

Keysight Technologies

Lightwave Catalog

2017 Test & Measurement Networks and Data Centers



Keysight M8040A 64 GBaud High-Performance BERT

- Bit Error Ratio Testers
- Digital Communication Analyzers
- Tunable Laser Sources
- Optical Power Meters
- Wavelength Meters
- Optical Attenuators and Switches
- Polarization and PER Analyzers
- Optical Modulation Analyzers
- Lightwave Component Analyzers
- Arbitrary Waveform Generators
- Oscilloscopes
- Digital Interconnect Test System
- Application Briefs
- Application Software

Introduction by Dr. Joachim Peerlings

Keysight in Digital and Photonic Test 2017



The technical world is changing faster than ever before. Big data analytics and machine learning technology provide new insights into processes and optimization in all industries.

Tremendous search capability in text, voice, images and video is opening new facets in our private lives.

Businesses get access to unlimited computing, video streaming and server power in the cloud at moderate cost, helping to speed returns.

This all is made possible through a huge communication network based on hyperscale data centers, long-distance and metro transport networks, but also a more and more refined wireline and wireless access network.

The underlying technology is based on:

- 100G and 400G optical transceivers for the client and line sides
- high speed interconnects at backplanes
- high speed interfaces between CPU and accelerators like FPGA and GPUs
- integrated optics (silicon photonics) for high density and energy efficiency

In the meantime, the brightest engineers are preparing the ground for 2020, when we expect billions of IoT devices (Internet of Things), Industry 4.0, autonomous cars, personal robots and assistants. This further challenges the network and needs creative thinking and smart solutions.

Engineers need a partner in test and measurement who can accompany each step in tackling these upcoming challenges.

Keysight is your T&M partner, offering solutions along the entire value chain, from component development to network equipment, of the communication network, addressing the latest technologies like silicon photonics, 400G PAM-x and coherent transmission.

Keysight supports your needs in research and development with high speed digital solutions for transmitter and receiver testing, but also for design and cost-effective manufacturing of quality optical components and modules.

Let me emphasize three new product innovations, which might be of interest to you.

M8040A 64 Gbaud High-Performance BERT

The Keysight M8040A is a highly integrated BERT for physical layer characterization and compliance testing. It supports PAM-4 and NRZ signals and data rates up to 64 Gbaud covering all flavors of 200 and 400 GbE standards. The M8040A BERT offers true error analysis and provides repeatable and accurate results, optimizing the performance margins of your devices.

The Digital Interconnect Test System PLTS 2017

The Digital Interconnect Test System PLTS 2017 is based on a VNA or TDR and has advanced signal integrity features for analyzing cables, connectors, PCBs and backplanes. Multi-domain analysis allows time, frequency, PAM-4 eye diagrams, RLCG, pre-emphasis, equalization, and channel operating margin figures of merit. A user friendly interface provides complex measurements with simple wizards including automatic fixture removal.

N109X DCA-M Optical/Electrical Sampling Oscilloscopes

For years engineers have trusted the DCA to provide accurate and easy measurement of digital communication waveforms. The Keysight N109X DCA-M family has built on that legacy by using the high-performance elements of both the 86100 oscilloscope mainframe acquisition system and the optical and electrical channel hardware of the 861XX plug-in modules. The N1090A supports 1 to 10 Gb/s measurements, while the N1092 and N1094 are for use from 20 to 28 Gb/s.

All our hardware and software solutions are designed to support programmability and automated testing.

Enjoy skimming through and referencing the new expanded 120-page Keysight Lightwave Catalog 2017.

Sincerely, Dr. Joachim Peerlings

Vice President and General Manager
Networks and Data Centers

Table of Contents

Introduction & New Product Announcements	
Introduction by Dr. Joachim Peerlings	03
Application Briefs	
81606A Tunable Laser Source – a look inside	06
Optical Transient Measurements	08
Swept-Wavelength Optical Measurement Solutions	09
Wavelength and polarization characterization of optical-to-electrical components	10
All-states method for PDL and PER	11
Choosing a detector for power measurement of 850 nm signals	12
Wavelength and polarization dependence of 100G-LR4 components	14
Optical Receiver Stress Test	16
Optical Modulation Analysis Tools	19
Coherent Transmitter and Modulator Test	21
Coherent Transmitter Test	22
Advanced research on OFDM	23
Research on Modulation Formats	24
Impairments in Complex Modulation Transmission	25
400G Reference Coherent Transmitter and Coherent Receiver	27
Optimizing Manufacturing Test Cost	28
Testing Transceivers Used in Fiber Channel Networks	29
Communications Waveform Measurements	30
Why is Physical Layer Testing Required? (PLTS 2017)	32
Lightwave Component Analysis	36
Application Software	
N7700A Photonic Application Suite	37
Tunable Laser Sources (TLS) & Fixed Sources (DFB & FP)	
81600B, 81602A, 81606A, 81607A, 81608A, 81609A Tunable Laser Modules	38
81960A, 8194xA, 8198xA and 81950A Compact Tunable Laser Sources	40
N7711A and N7714A Tunable Laser Source	43
81663A DFB Laser Module	45
8165xA Fabry-Perot Laser Modules	46
Optical Power Meter	
N7744A and N7745A Optical Multiport Power Meter	47
N7747A and N7748A High Sensitivity Optical Power Meter	48
8163xA/B and 8162xB Optical Power Meters	49
81610A and 81613A Return Loss Modules	53
Polarization Products	
N7781B Polarization Analyzer	54
N7782B PER Analyzer and N7783B Thermal Cycling Unit	55
N7784B, N7785B, N7786B Polarization Controllers	57
8169A Polarization Controller	59
N7788B Optical Component Analyzer	60
Multi-Wavelength Meter	
86120D and 86122C Multi-Wavelength Meters	62
Optical Attenuator & Optical Switches	
8157xA High-Power Optical Attenuators	64
N775xA and N776xA Multi-Channel Optical Attenuators	66
81595B, N7731A and N7734A Optical Switch	68

Table of Contents (cont.)

Lightwave Component Analyzer (LCA)	
N4373D Lightwave Component Analyzer (Single-Mode)	69
N4374B Lightwave Component Analyzer (Single-Mode)	70
N4375D Lightwave Component Analyzer (Single-Mode)	71
N4376D Lightwave Component Analyzer (Multimode)	72
Optical Modulation Analyzer (OMA) & ICR Test	
N4391A Optical Modulation Analyzer	73
N4392A Portable Optical Modulation Analyzer	74
N4392A Integrated Coherent Receiver (ICR) Test	76
N7786B Polarization Synthesizer for Integrated Coherent Receiver (ICR) Test	79
Oscilloscopes & O/E Converter	
Infiniium Z-Series Oscilloscopes	80
N7004A Optical-to-electrical Converter	81
Infiniium V-Series Oscilloscopes (8 to 33 GHz)	82
Arbitrary Waveform Generator (AWG)	
M8190A 12 GSa/s Arbitrary Waveform Generator (AWG)	83
M8195A 65 GSa/s Arbitrary Waveform Generator (AWG)	85
M8196A 92 GSa/s Arbitrary Waveform Generator (AWG)	87
Bit Error Ratio Tester (BERT)	
J-BERT M8020A High-Performance BERT	88
M8062A 32Gb/s BERT Front End	89
M8040A 64 Gbaud High-Performance BERT	90
N4960A Serial BERT 32 and 17 Gb/s	91
N4980A Multi-Instrument BERT Software	94
Digital Interconnect Test System	
Digital Interconnect Test System PLTS 2017	95
Optical Receiver Stress Test (ORST)	
N4917B Optical Receiver Stress Test Solution	96
81490A Reference Transmitter	98
Digital Communication Analyzer (DCA)	
N1076A, N1077A CDR Solutions	99
N109X DCA-M Optical and Electrical Sampling Oscilloscopes	100
N1090A, N1092A/B/C/D/E and N1094A/B DCA-M Configurations	102
86100D Wide-Bandwidth Oscilloscope	103
86108B Precision Waveform Analyzer	109
SMUs	
B2901A/02A/11A/12A Precision Source/Measure Unit (SMU)	110
B2961A/B2962A 6.5 Digit Low Noise Power Source	111
LIV Test of Laser Diode Using the B2900A Series of SMUs	112
B2900A Series of SMUs comes with a range of free Software Options	113
Quick I/V Measurement Software and EasyEXPERT Group+	114
Selection Tables & Accessories	
Accessories	115
Sometimes, innovation is in the smallest part	117
Optical Power Meter Selection Table	118
Tunable Laser Source Selection Table	119
BERT Selection Table	120

81606A Tunable Laser Source - a look inside

www.keysight.com/find/81606

The new 81606A is the top of our tunable laser family, with a new level of performance for rapid wavelength dependent measurements.



- More than 10 mW signal power with even lower spontaneous emission background
- Better wavelength accuracy, repeatability and resolution at all sweep speeds
- Faster maximum sweep speed and shorter acceleration zones at sweep endpoints
- Bidirectional measurement sweeps

For results in practice, this brings:

- The widest dynamic range for measuring the spectral transmission of wavelength-selective components, especially combined with Keysight optical power meters and software
- Extreme accuracy and repeatability on both wavelength and power scales for confidence in spectral test tolerance limits
- The ability to repeat such measurements at a high rate, even over a wide wavelength range, for real-time feedback in adjustment and calibration procedures

Key Performance Features

- Wavelength: 1450-1650 or 1490-1640nm
- Sweep speeds: up to 200 nm/s
- typ. max. power: >12 dBm peak
- typ. signal to SSE ratio: ≥ 80 dB/nm
- typ. λ accuracy: ± 2 pm static, ± 3 pm sweeping

A new cavity design makes it possible

The 81606A is built around a new cavity design for improved spectral purity: lower SSE, lower SMSR at higher output power.

The drive unit has been redesigned for better acceleration and sweep linearity which makes it the ideal actor for the laser's closed-loop tuning control.

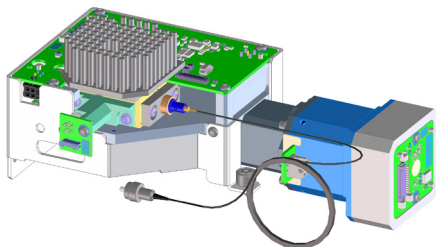

The multi-axis dynamic control during sweeps and the resulting wavelength accuracy, and power and mode stability are supported by a new high-bandwidth wavelength monitor including a gas-cell reference. The mechanical drive is also further developed for high speed sweep control, fast acceleration and qualified for long life.

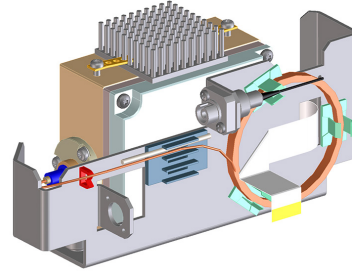

The novel wavelength reference unit

A new laser module design

The redesigned laser module contains a new, higher-output gain chip and a novel beam splitter for lower SSE. A monitor provides additional feedback for the active tuning control loop.

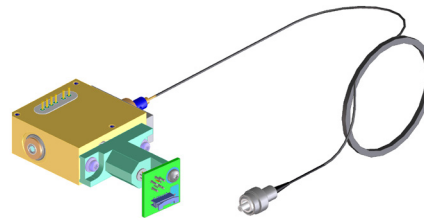

15 dB more dynamic range

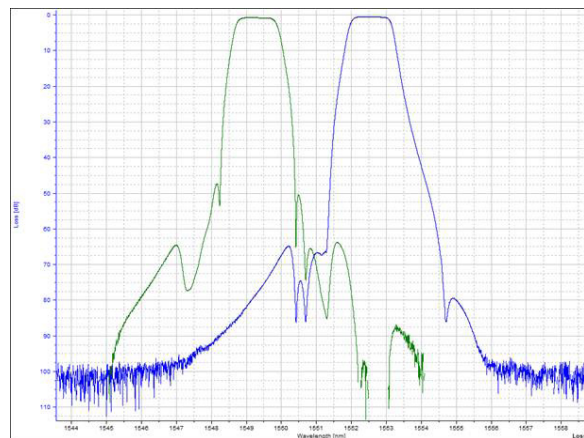

2 channels of a DWDM demultiplexer measured with the N7747A high-sensitivity power meter at 50 nm/s: low SSE and high-sensitivity linear detectors uncover filter details to 100 dB dynamic range. The low total SSE benefits notch filter and interleaver measurements, showing depths beyond 70 dB.

www.keysight.com/find/81606

Our innovative technology is supported by the mature experience and continuous research in our calibration and test procedures, which allow a statistically solid and traceable basis for confidence in our published specifications.

Keysight 81606A - Designed for Best Accuracy

While static wavelength accuracy can be verified with a wavelength meter, that isn't enough to confirm the dynamic accuracy during a sweep. As an illustration of the dynamic accuracy achieved by the laser with its internal reference unit, these figures show the offset of spectral lines, when measured at full 200 nm/s speed with 0.5pm resolution.

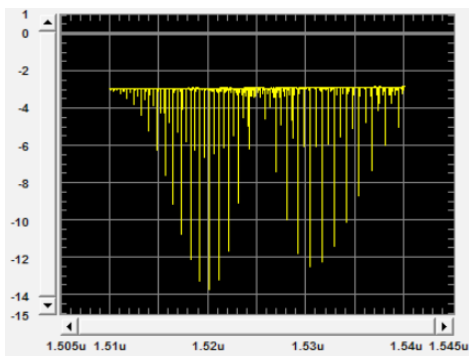

Absorption lines of a C2H2 gas cell

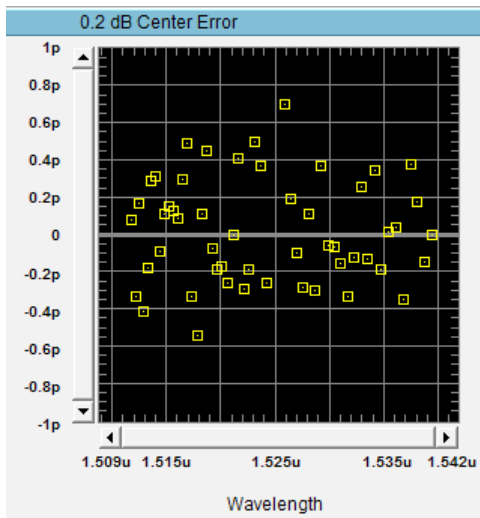

Less than ± 1 pm deviation of the measured center wavelengths from the known values (according to NIST SRM 2517a) acquired at 200 nm/s sweep speed

Spectral loss testing on up to 8 channels in a single box

The 81606A Tunable Laser Source module in an 8164B Lightwave Measurement System mainframe, plus up to four dual power sensor modules, is sufficient for 8-channel devices, such as a CWDM multiplexer.

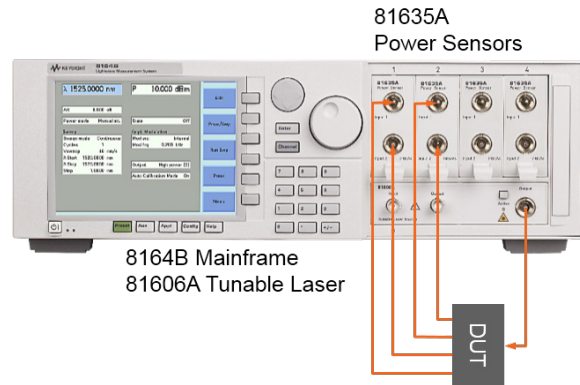

The N7700A photonic application suite helps getting to results fast.

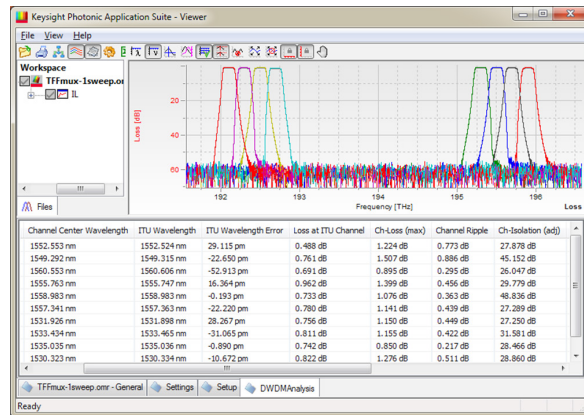

Protect Your Investment

As a successor to the industry-standard 81600B, which we expect to continue in service for many years, the 81606A has also been designed to maximize compatibility with existing test stands and software.

- The modular 81606A uses the same 8164B mainframe slot and works with the same firmware version and the same front panel controls
- The N7700A application software engines can be updated online to versions that use both models and add the new 81606A functionality
- The 816x VXI Plug&Play driver, widely used in customized software, can be updated to recognize the new model and operate in the same way, while providing enhanced spectral performance
- The SCPI command set remains the same and has a few extensions for the additional functionality

Applications

Optical Transient Measurements

www.keysight.com/find/mppm

Making transient optical power measurements with the N77-Series multiport optical power meter

Measuring optical power level changes, to determine fiberoptic switching times or to observe transient fluctuations from fiber movement or network reconfiguration, goes beyond the design of most fiberoptic power meters. These instruments are generally designed for calibrated determination of optical power levels that are constant or change in synchronization with other instruments. The typical sample rates like 10 kHz, data capacity of perhaps 100,000 samples, and data transfer speed to the controller are often insufficient for general time-dependent measurements. Instead alternative setups, like a fast optical-to-electrical converter combined with an oscilloscope, have been used and described in standards. These often sacrifice optical power calibration, involve additional integration effort, and are likely implemented with an over-dimensioned scope bandwidth.

The N7744A 4-port and N7745A 8-port optical power meters now offer the performance to make these measurements with a small self-contained programmable instrument that is used together with a controller computer. These power meters accurately log optical power at selectable sample rates up to 1 MHz, store up to 2 million samples per port, allow fast data transfer via USB or LAN and support simultaneous measurement and data transfer for continuous power monitoring without interruption.

Now the new N7747A and N7748A high sensitivity power meters can be used in the same way, with the difference that the lower bandwidth reduces the sampling rate to 10 K/s, but with lower noise and for much weaker signals. This can be optimal for transient crosstalk measurements.

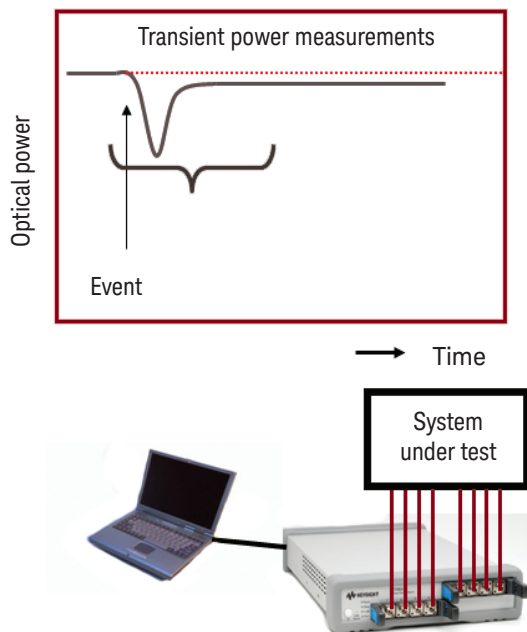

Logging functionality basics

The measurement of time-dependent signals is realized with the easy-to-use logging function of the optical power meters. The logging function is set up by choosing the number of logging samples, N , and the averaging time of each sample, t . The logging measurement is then started with a programming command or an electrical trigger. The instrument can be configured to make the complete logging measurement of N samples or individual samples when triggered. For logging time-dependence, the measurement will usually be configured for logging all samples without pause over a total time Nt .

For completeness, note that the instruments also have a stability function that performs similarly, but with a programmable dwell time between samples. This is used for measuring longer term changes in optical power, as for source stability tests, and is not discussed here further.

The N7744A and N7745A multiport power meters, MPPM, can perform this logging simultaneously on optical signals from up to 8 fibers. The averaging time can be chosen between 1 μ s and 10 s, and up to 1 million samples can be taken. During the logging, a wide dynamic range can be recorded, exceeding 60 dB for averaging times of 100 μ s or more, and the power range maximum can be chosen between -30 dBm and +10 dBm in 10 dB steps. The MPPM can also be configured to begin a new logging measurement of N samples as soon as the previous measurement finishes. The existing results can be uploaded to the controller computer during the new measurement. This set of functionality provides two methods for making transient measurements, which we label here as triggered logging and continuous logging methods.

Triggered logging is used to measure a fixed number of samples, starting from a time chosen by software or an electrical signal to synchronize with the event to be measured. This is most useful when the timing of the event to be measured is also controlled, as for setting a switch or shutter, changing an attenuator, or blocking an input signal to an amplifier or ROADM (reconfigurable add/drop multiplexer). Since 1 million samples can be stored per port, a single logging measurement is usually sufficient. The multiple ports of the instrument make it easy to watch, for example, all output ports of a switch during reconfiguration. Measurements like described in the IEC standard 61300-3-21 for switching time and bounce time or transient characterization of optical amplifiers can be accomplished with this method.

Continuous logging is especially useful for recording events with unpredictable timing as well as for keeping a very large number of samples. A typical application would be the measurement described in IEC 61300-3-28 for transient loss, where the power from fibers is monitored for change due to mechanical disturbances. This method can be programmed using the same logging function mentioned above, with the extension that the complete logging sequence is repeated multiple times. For such real-time processing while data is being gathered, multi-threaded programming is useful to avoid interruption of the data stream, as now available in Keysight VEE 9.0 and higher.

For a more detailed description refer to: Application Note 5990-3710EN: Making Transient Optical Power Measurements with the N7744A and N7745A Multiport Optical Power Meter.

www.keysight.com/find/n7700

Swept-wavelength measurement solutions

Tunable laser instruments are used for spectral measurements of optical components and materials. The wavelength dependence is rapidly determined with selectable and very high wavelength resolution. The measurement systems can be flexibly configured to match the requirements of the application. Here we suggest some examples.

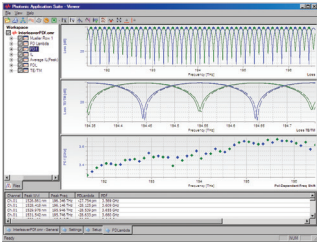

Insertion loss measurement (IL)

Combining one or more optical power meters with the tunable laser source (TLS) permits measurement of optical power vs. wavelength. Often this is used to find the ratio of power at the input of a component to the output power, commonly called insertion loss and expressed in dB. While the TLS tunes the wavelength over the chosen range, the power meters periodically sample the power for the desired number of measurement points. These samples are synchronized with the TLS sweep by a trigger signal for accurate association with the corresponding wavelength. Use of multiple power meters allows simultaneous measurement of outputs from multiport components like multiplexers, splitters and wavelength switches. A setup can combine the 81606A, 81600B, 81960A, 81940A or 81980A TLS with power meters from the 816x-series modules or the N774x-series multiport power meters and the free N7700A IL software. Easy programming of these “lambda scan” routines uses the free 816x Plug&Play driver and can be enhanced with the N4150A Photonic Foundation Library (PFL) of measurement functions. Reflection spectra (return loss) can also be measured, by connecting the 81610A return loss module after the TLS.

Performance considerations

High wavelength accuracy and repeatability, particularly during fast wavelength scans, is assured with the built-in wavelength monitoring in these laser sources. These “lambda-logging” data are synchronized with the measurement triggers to the power meters. For highest absolute and relative wavelength accuracy during high-speed sweeps, the 81606A includes a built-in gas cell reference and faster bandwidth and sampling by the wavelength monitor.

InGaAs power detectors are best for such measurements due to the small variation in responsivity over the single-mode fiber wavelength range (1260 to 1630 nm) and high sensitivity and dynamic range. The N7744A and N7745A power meters are especially well adapted to these swept-wavelength measurements with fast sampling rates and high signal bandwidth that allow high-resolution measurements at high sweep speeds without distortion of the measurement trace. Faster data transfer raises throughput dramatically, especially at high port counts. When measuring weaker signals, like for channels with crosstalk better than -60 dB or when the laser power is split to multiple devices, the N7747A or N7748A power meters can be used. The cooled detectors and low-noise amplifiers provide the highest sensitivity.

When insertion loss is low at some wavelengths and very high at others (high dynamic), like in DWDM components, it is very important that the broadband spontaneous emission from the TLS is very low. This avoids light transmitted in the passband of the component when the TLS wavelength is outside this band especially for measuring components with more than 40–50dB dynamic. The 81606A TLS provides light with practically no source spontaneous emission (SSE), even very close to the laser line. The dynamic range of the power meters is then important too. Keysight power meters use linear transimpedance amplification of the detector photocurrent for stability and accuracy, even at low power and high sampling speed. For fast measurements of dynamic up to about 55 dB, the N7744A and N7745A can do this with a fixed power range during a single wavelength sweep of the laser. Even more range is achieved by measuring with multiple power ranges and “stitching” the traces to capture both the strongest and weakest signal, especially when using the high sensitivity N7747A or N7748A. The N7700A FSIL and IL engines, as well as the 816x Plug&Play driver provide such stitching automatically.

Polarization dependent loss (PDL)

Optical signals are generally polarized and the variation in insertion loss with polarization must be determined. Measurement involves determining the maximum and minimum IL vs. polarization for all desired wavelengths, and all combinations of linear and circular polarization. Fortunately this can be done by measuring swept-wavelength IL at a set of four (or optionally six) polarizations, from which any other IL can be calculated. This is known as the Mueller Matrix method. The setup includes a polarization controller after the TLS, that sets the polarization of the light into the device under test. The 8169A polarization controller does this by sequentially setting each polarization for separate TLS sweeps, support by the PFL software. But the newer N7786B rapidly switches polarization and monitors the SOP and power so PDL can even be measured in one wavelength sweep. This innovative method and calculations such as resolution of TE/TM spectra and determination of polarization dependent wavelength are provided in the N7700A IL/PDL engine software.

Dispersion (PMD and DGD)

At high data rates, like 10 Gb/s and faster, the variations in time required for parts of the signal to pass through the network causes data pulses to broaden. The way this timing, group delay (GD), varies is called dispersion.

The dependence of GD on polarization is called polarization mode dispersion (PMD) and described by differential group delay (DGD) spectra, the difference between the GD for the fastest and slowest polarizations in the component. This too can be measured with swept wavelength at a set of polarizations, but also requires a polarization analyzer as a receiver. This method is called Jones Matrix Eigenanalysis and is supported by the N7788B component analyzer together with a TLS. This system measures single-channel DGD, PDL, IL and other advanced parameters does this with a single wavelength sweep for optimum stability and speed, using the N7700A Polarization Navigator.

Further details can be found in the brochure for the “N7700A Photonic Application Suite”, 5990-3751EN and “Programming Keysight Technologies Continuous-Sweep Tunable Lasers”, 5992-1125EN.

www.keysight.com/find/n7700



There is an increasing number of fiberoptic components that integrate photodiodes with passive optical functionality and with electronic circuits. Important examples are:

- Integrated coherent receivers (ICR)
- 100GBASE-(C)LR4 ROSA components ROSA components
- Optical channel monitors

These all have optical input ports and electrical or RF output ports. The photodiodes produce photocurrent from the optical signal after it has passed the passive sections, such as polarizer, splitter, or interferometer. Thus the responsivity of the photodiodes to the input signal, measured in mA/mW, in dependence of wavelength and polarization is a fundamental performance measure of the component.

Measurement of such devices can be made in the same way as mentioned on Page 9 for PDL, by replacing the optical power meter with an instrument for logging photocurrent. The N7700A-100 IL/PDL engine software supports this setup.

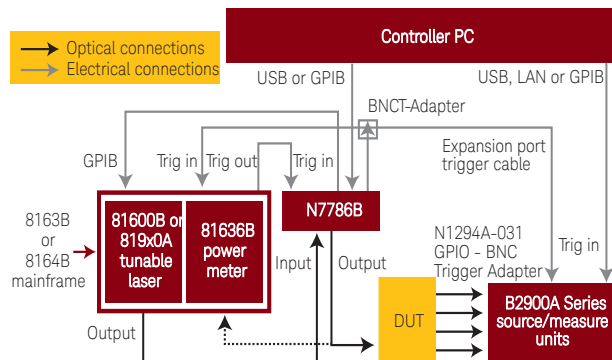

Setup example for measuring optoelectrical devices with the B2900A

From the swept-wavelength measurement of the input optical power and the output diode current, the responsivity spectra are calculated as the average vs. state of polarization.

The maximum and minimum responsivity vs. SOP are also determined, which is especially useful for polarizing components like ICR for polarization. multiplexed signals. The polarization dependence is also displayed as PDL and the TE/TM traces are also calculated, as for optical-optical measurements.

For balanced-detection components, the common-mode rejection ratio (CMRR) of detector pairs is also determined.

The N7700A-100 software also has added functionality for measuring high PER with an additional measurement step that continuously scans a large number of SOP at a set of fixed-wavelength points. The user can choose the number of points to balance measurement time vs resolution. Good accuracy to well beyond 20dB can be obtained.

For devices like ICR, where the photocurrent is converted to an RF output signal, the "CW" photocurrent can typically be accessed from the pins for applying bias voltage.

For higher flexibility in the polarity and isolation of the biasing, the B2900A-series source measure units can also be used for detection, as shown here.



B2900A-series source measure unit

Support for these instrument is added to the N7700A-100 IL/PDL engine.

Further details can be found in the brochure for the N7700A Photonic Application Suite, 5990-3751EN and "Wavelength and polarization dependence of 100G-LR4 components", 5992-1588EN.

All-states method for PDL and PER

The all-states PDL method for measuring polarization dependent loss by scanning the polarization of light input to the DUT over a large sampling of all possible states is a good way to measure components with little wavelength dependence, so that the wavelength can be fixed during the scanning. Fiberoptic couplers, splitters and isolators are typical components to test this way. Tests of polarization beam splitters and other devices designed for high PER also benefit from this method, because it samples the states with high polarization extinction.

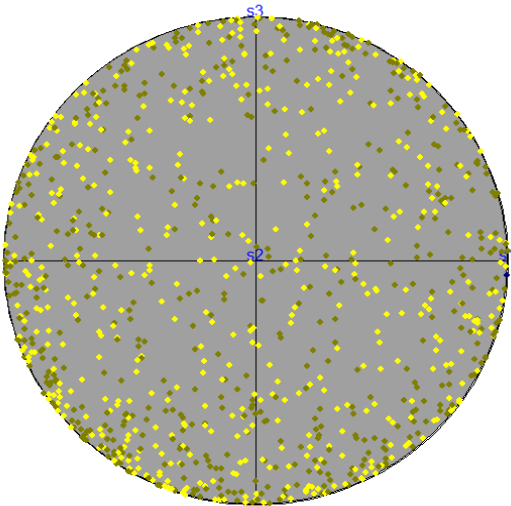

Random sampling of SOP, represented on the Poincaré sphere.

Conventionally, this method has been realized by monitoring output optical power while scanning the input polarization, so that the accuracy is limited by the polarization dependence of the instrumentation, particularly the polarization controller. This was generally addressed by using mechanical movement of fiber loops, which can give very low polarization dependence of the power level, but has limited speed.

Faster accurate measurements now use the Keysight N7785B synchronous scrambler, which can be programmed for repeatable stepping through a sequence of polarization states at high speed while producing synchronization triggers. This can be used to shorten total measurement time, allow optimized detector averaging times, and normalize the results to remove the polarization dependence of the setup from the results.

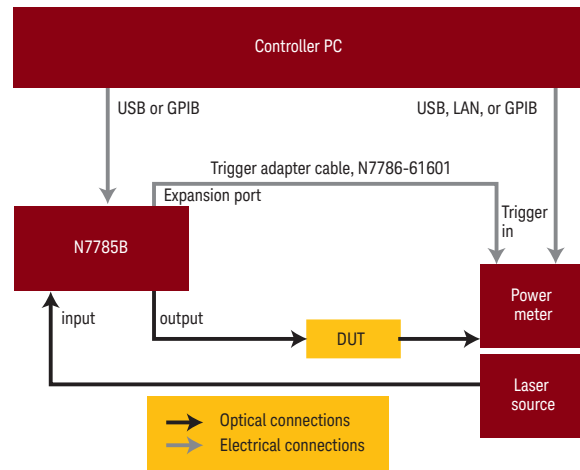

A typical setup for synchronized all-states measurement.

For measuring PDL values up to 1 dB, about 100 samples are sufficient for the minimum/maximum ratio to come within 10% of the full PDL value. So a good measurement is achieved in less than 50 ms using 100 μ s averaging time. For measuring PDL values significantly below 0.1 dB, the noise is a limitation and longer averaging time is needed. Using 10 ms averaging time with a stable setup has been seen to give repeatability corresponding to less than 0.005 dB over times of 10 minutes or more. The 10 ms averaging time also supports use of the coherence control function of the laser sources, if needed to avoid interference effects due to reflections in the setup. Again for these values, good measurements are obtained with sequence lengths of about 100.

The range of high extinction ratio measurements amounts to how well the lowest transmission value is determined. When using a random pattern of SOP, this is improved by using many samples and having minimum SOP variation during the averaging time of the sample. This latter condition is an advantage of the polarization switching vs. continuous scanning. To assure measurements above 30 dB PER, a minimum of 20 k samples is recommended. For example, using 100 μ s averaging time, the 20 k sequence requires 8 s.

For further details, refer to 5990-9973EN, "All-States Measurement Method for PDL and PER with a Synchronous Polarization Scrambler - Application Note".

NEW

General

Optical power meters for testing fiberoptic components use semiconductor photodiodes as detectors to generate electrical current proportional to the incident optical power. This photocurrent is then measured, typically with a transimpedance amplifier and analog-to-digital converter, to determine that power. That requires the conversion factor from mA current to mW power, which depends on the wavelength of the light and combines contributions from the properties of the detector as well as any optics used to collect the light. Calibration of the power meter thus involves tracing and recording the wavelength dependent responsivity and including this data with the instrument.

Responsivity is key

This responsivity is one of the key considerations in choosing a power meter for a particular application. First, the instrument must be calibrated at the wavelength of the light to accurately determine the absolute power level. If only relative power change will be measured, as for determining the attenuation of a passive optical component, this calibration factor is not actually needed. However it is still necessary that the detector has sufficient responsivity for this wavelength. For measuring light that is distributed over a range of wavelength or for which the wavelength is not accurately known, it is also important that the variation of responsivity over wavelength is not too large.

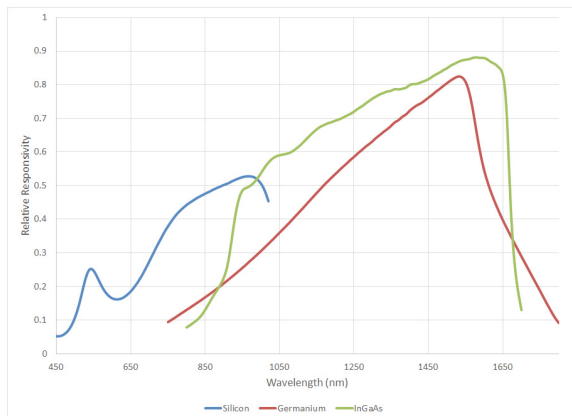

Wavelength dependent responsivity examples for three power meters with different detector materials

Responsivity examples for different detector materials

Example responsivity spectra for power meters based on three commonly used semiconductor materials are shown in the figure above. These are actual calibration data for individual instruments and the curves can vary somewhat from unit to unit, but the spectral shapes are primarily determined by the detector material. The values displayed on the y-axis correspond approximately to conversion efficiency in mA/mW. For wavelengths supported by standard single-mode fiber from about 1250 nm to 1650 nm, the InGaAs detector (like used here in the Keysight 81624B optical head) provides the highest performance

www.keysight.com/find/oct

with high responsivity and relatively low wavelength dependence. InGaAs (actually a shorthand label for the alloy chemical formula $\text{In}_x\text{Ga}_{1-x}\text{As}$) as a direct-gap semiconductor also typically provides the lowest noise level which permits power measurements over the widest dynamic range.

Make your choice

The germanium detector (81623B) is useful over an even wider wavelength range and is less expensive, so these make good general purpose power meters. However the steep wavelength dependence above about 1545 nm makes the measurements more sensitive to wavelength uncertainty or instability. For shorter wavelengths, including visible light, the silicon detector (81620B) provides good responsivity. This can be used for the 650 nm red light used with POF (plastic optical fiber), but as discussed in the following is also an attractive alternative to germanium for the widely used 850 nm wavelength range.

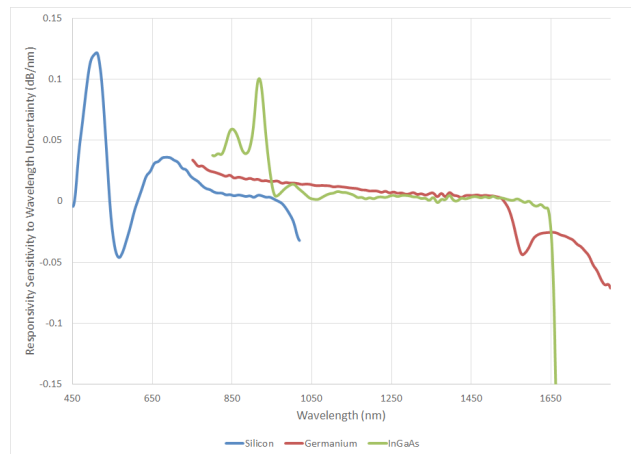

Sensitivity of the responsivity to wavelength, calculated from the responsivity slope

NEW

850 nm power measurement

Fiber links for transmission over short distances, like within buildings and data centers, predominantly use multimode fiber and signals at 850 nm. Another less common wavelength used with this fiber is 1300 nm. The wavelength here is a nominal value and the actual wavelength can be offset substantially. For example the IEEE 802.3 standard requires center wavelength to be between 840 nm and 860 nm. Other applications may tolerate wider wavelength variation. If the actual wavelength of such sources is not used to make the power measurement, this variation contributes to the measurement uncertainty. With this in consideration, the silicon detector has clear advantages. The responsivity is about five times stronger than for germanium, which itself is stronger than for the InGaAs detector. But more important for measuring moderate signal levels like 1 mW is the dependence on wavelength, as shown expanded for this wavelength range in the figure below.

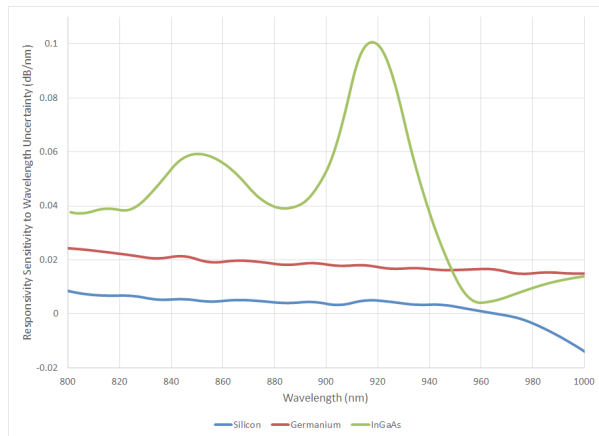

Sensitivity of the responsivity to wavelength, calculated from the responsivity slope, for the short wavelength region

It depends on the application

The germanium has moderate dependence, but a 10 nm wavelength offset will still cause about 0.2 dB measurement error (4.7%), which is large compared to the $\pm 4.0\%$ uncertainty specification or the 81623B when the correct wavelength setting is used. The comparable error for the 81620B with the silicon detector is only 0.05 dB.

This low wavelength dependence can also be convenient if additional wavelengths are used in this region, such as the 4 wavelength channels between 850 nm and 940 nm defined for the SWDM grid.

On the other hand, if a multimode fiber test setup will be used for both 850 nm and 1300 nm wavelengths, then the germanium detector is the best choice since silicon is not useful at the longer wavelengths, where the photon energy is smaller than the semiconductor bandgap.

www.keysight.com/find/oct

Considering other dependency

Finally when considering the requirements for accuracy specifications, the impact of other dependency besides wavelength should be considered. For measuring polarized light, like most laser signals, the polarization dependence can be a significant source of uncertainty because the polarization at the output of most optical fibers is not stable and changes with temperature and movement of the fiber. For measuring coherent light, again like laser signals, the impact of possible multiple reflections between the power meter optics and the fiber connector output leads to measurement instability, so such reflections should be minimized. This is characterized in the Keysight specifications as "spectral ripple" because the coherent interference will vary periodically with wavelength.

Additional functionality Programming

Keysight optical power meters do support a programming command to read out the wavelength responsivity calibration data (like used for the graphs in this document). This can be used for example in post-processing to get calibrated absolute power values without needing to change the wavelength setting of the power meter each time that the wavelength of the signal is changed. That can be especially helpful when the power meter logging function is used to record a series of samples, during which the wavelength setting cannot be changed. When used together with a tunable laser, this can provide the input power to a device under test, while the wavelength is swept. That is important for example to measure O/E conversion devices. It can also be used to normalize a reference measurement made on one power meter port for use as reference on other power meter ports connected to the device.

Additional functionality - Logging

Besides simple power measurements, Keysight optical power meters provide higher functionality, especially including the logging function just mentioned and flexible internal and external triggering functions for synchronization with other instruments or the DUT itself. The optical head models mentioned above have memory for up to 20k samples with individual averaging times selectable between 100 μ s and 10 s duration. Other models support logging of up to 1M samples and averaging times down to 1 μ s. The optical heads also provide an analog output signal with a voltage proportional to the input optical power. Especially combined with the large 5 mm diameter detector area, this supports various automated alignment procedures. The heads can be used to measure open beams and have a selection of fiber connector adapters. As external heads connected to the mainframe with a cable, these can be located conveniently on optical tables or workbenches.

NEW

With the need for 100 Gb/s links in data communication, the IEEE 802.3 Ethernet Working Group has included implementations for reach up to 10 km (100GBASE-LR4) or, with tighter tolerances, 30 km (100GBASE-ER4) by using four wavelength channels in single mode fiber, centered at: 231.4 THz (1295.56 nm), 230.6 THz (1300.05 nm), 229.8 THz (1304.58 nm), 229.0 THz (1309.14 nm).

Spectral measurements for passive components

The spectral response of components used in WDM links is a key factor in determining link performance at the physical level. The insertion loss (IL) of passive components influence the signal power budget. The wavelength selectivity of filters used for multiplexing and especially demultiplexing, characterized from traces of IL vs. wavelength with parameters like ripple or flatness in the passband and isolation of wavelength outside the passband, is important for signal stability and avoiding crosstalk. Reflections, parametrized as return loss (RL), can also degrade link performance and should be controlled. Low dependence of these response parameters on the polarization of the optical signal is also needed to avoid fluctuations in power, because the polarization state can change randomly along fiber links. So passive WDM components are typically tested and verified by measuring IL, PDL and often RL across the applicable wavelength range. Using a tunable laser source at the common side of an LR4 multiplexer, for example, allows all four lane ports to be measured simultaneously with synchronized power meters. A block diagram for such measurements is shown below, implemented using the N7700A-100 application software package. Details for the instrumentation are given further below.

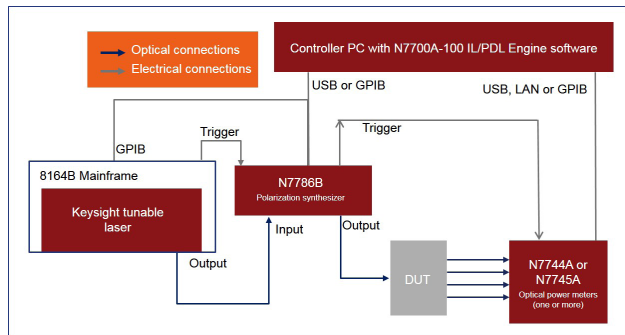

Block diagram for swept-wavelength IL & PDL measurements

As shown in the measurement results diagram the insertion loss spectrum for each output port, averaged over all states of polarization. That would be the IL of unpolarized input signal. Spectra of the polarization dependent loss are also determined. This can also be shown as two IL spectra for each port corresponding to the IL for the input polarization states for maximum and minimum transmission. For planar devices like wafer chips, this usually corresponds to polarization parallel or perpendicular to the chip surface (TE or TM).

The N7700A software also provides for calculation of key analysis parameters for the passbands, like wavelength offset, bandwidth, isolation, ripple and maximum in-channel IL and PDL.

www.keysight.com/find/n7700

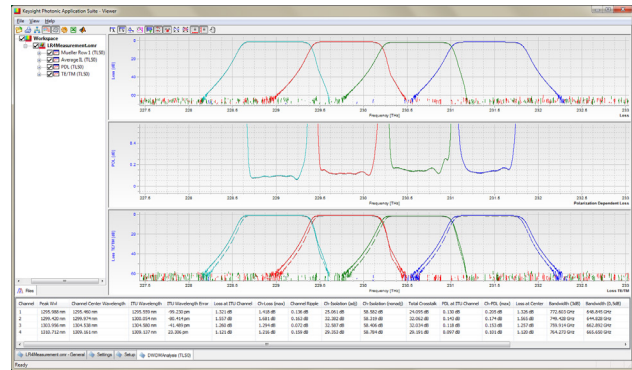

Measurement result for a 4-port multiplexer, including data analysis

Spectral measurements for components with integrated detectors

Another class of components requiring similar measurements is increasingly important. The optical detectors used in receivers are also characterized with respect to relevant wavelength and polarization dependence, but the response usually doesn't have strong variation. However when the detectors are integrated with filters or other passive components, this assembly needs to be characterized in a similar way as for the individual components. An important example is the LR4 receiver optical subassembly (ROSA), which can include the demultiplexer optics, photodiodes for detecting each signal lane, and often some electronics for transimpedance amplification for the RF signal carried on the detected photocurrent. Such a structure is shown schematically in figure below.

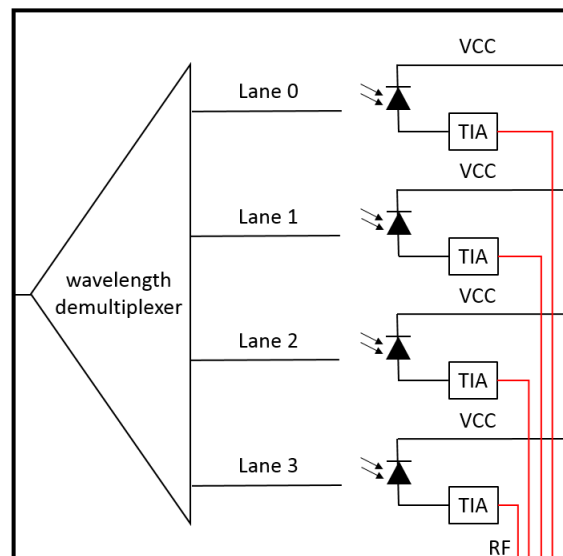

Schematic diagram of an LR4-ROSA device



The electrical contacts on the ROSA that are used for providing bias voltage to the photodiode detectors can also be used to access the photocurrent while an input optical signal is varied in wavelength and polarization to measure responsivity response parameters. Such a solution is shown in the diagram below.

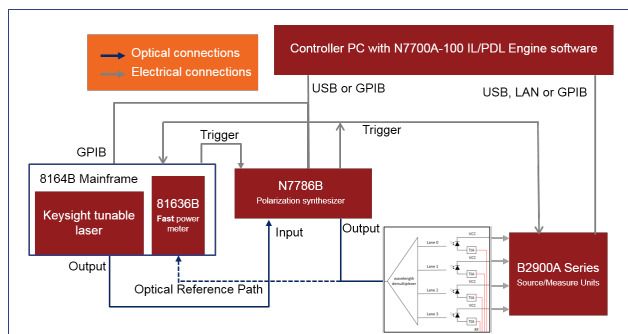

Block diagram for measurements of wavelength and polarization dependent responsivity

This measurement uses source/measure units to apply bias voltage and measure the photocurrent from the integrated detectors of the DUT. The results are then interpreted as responsivity in units of mA current per mW optical input power. So the absolute input optical power is measured with an optical power meter and then applied to the DUT. Again both the polarization-averaged response as well as the minimum and maximum responsivity vs. polarization are determined by the software. An example is shown below.

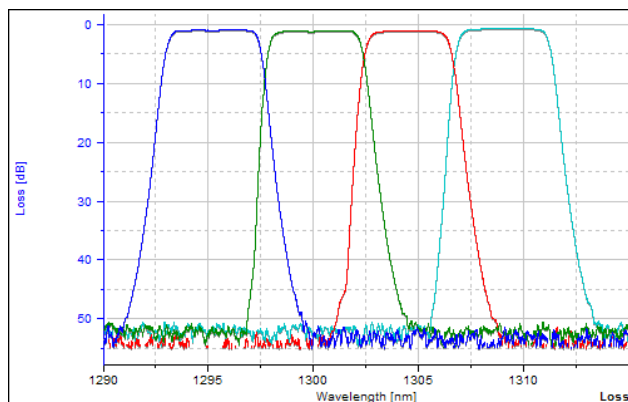

Sample measurement of an LR4-ROSA device

www.keysight.com/find/optical_stress

The fundamental test for these network elements is the bit error ratio, demonstrating reliable operation in digital data transmission systems and networks. The basic principle is simple: the known transmitted bits are compared with the received bits over a transmission link including the device under test. The bit errors are counted and compared with the total number of bits to give the bit error ratio (BER). The applied test data signal can be degraded with defined stress parameters, like transmission line loss, horizontal and vertical distortion to emulate worst-case operation scenarios at which the device under test has to successfully demonstrate error free data transmission. Obviously, this test is of fundamental importance for receiving network elements, due to the manifold impairments occurring on optical transmission lines. Therefore, many all optical transmission standards define such stressed receiver sensitivity on the basis of a BER measurement. The basic test methods and setups are usually very similar. However, the test conditions, the stress parameters or methods of stress generation vary from standard to standard, depending on the application area, transmission medium, data rate or data protocol.

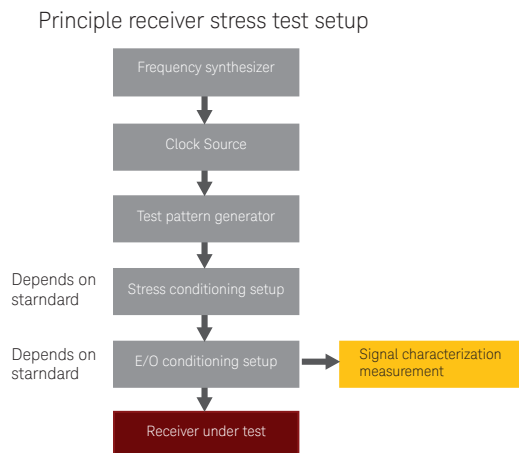

OMA: Optical Modulation Amplitude, measured in $[\mu\text{W}]$ ("average signal amplitude")

ER: Extinction Ratio, high-level to low-level, measured in [dB] or [%]

UI: Unit Interval (one bit period)

LR, SR, ER: Flavors of 10 Gb Ethernet standard for Long Reach (10 km), Short Reach (300 m), Extended Reach (40 km)

AO: Vertical eye opening ("innermost eye opening at center of eye") [dBm or μW]

VECP: Vertical Eye Closure Penalty

SEC: (for SR4) Stressed Eye Closure, measured in [dB] ("innermost eye opening with ISI")

The basic setup is sketched in the block diagram and consists of the following elemental building blocks:

- The frequency synthesizer: creates sinusoidally jittered clock, Periodic Jitter (PJ)
- The clock output from the clock source will be modulated with the sinusoidal jitter
- The electrical pattern generator creates the defined test pattern at the required rate
- The electrical stress conditioning setup adds various kinds of signal distortion onto the test pattern
- The E/O conditioning setup modifies the electrical stress signal depending on the standard:
 - The electrical-to-optical- converter converts the electrical stressed test signal into the corresponding optical stressed signal (10 GbE, 10 GFC)
 - The tunable E/O source, optical multiplexer and modulated test sources are used to emulate other lanes for higher speed standards (40 GbE, 100 GbE)
 - The optical attenuator emulates the transmission line loss and sets the optical modulation amplitude to the required level
- The optical stressed signal is fed to the optical receiver under test
- The receiver's data output signal is lead to the error detector, which compares the input and output data test patterns, detects errors and calculates the bit error ratio

What is optical stress?

Figure 3 illustrates an optical stressed signal which has to be applied to an optical receiver. While such a signal is applied to the optical input, the bit error ratio at the receiver's output has to be below a certain level (typically $1e-12$) to be compliant.

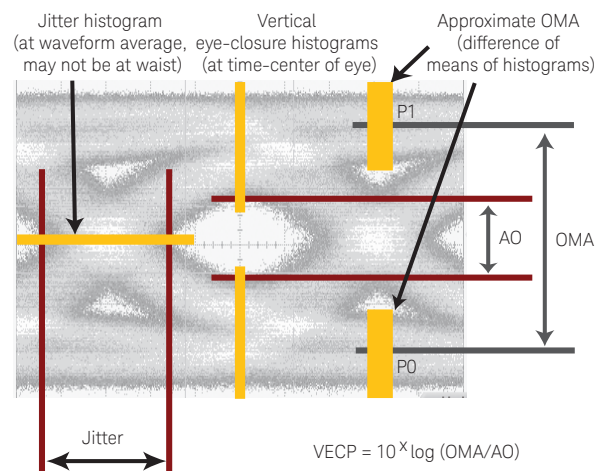

Definition of the optical parameters

www.keysight.com/find/optical_stress

Stress conditioning setup:

Stress conditioning varies depending on the standard and the speed class of the component. But the principle of stress conditioning remains the same:

- First, this block adds different types of jitter, like random jitter, periodic jitter or sinusoidal jitter, to generate defined horizontal closure of the test pattern's eye shape
- Second, this block exposes different types of amplitude distortions, like sinusoidal amplitude interference and low-pass filtering, to generate defined vertical closure of the eye-shape

Stress conditioning for 10 GbE and 10 GFC

- 4th Order Bessel Thomson Filter: Creates ISI-induced Vertical Eye Closure (VECP)
- Sinusoidal Amplitude Interferer: Causes Sinusoidal Jitter (SJ) in conjunction with limiter

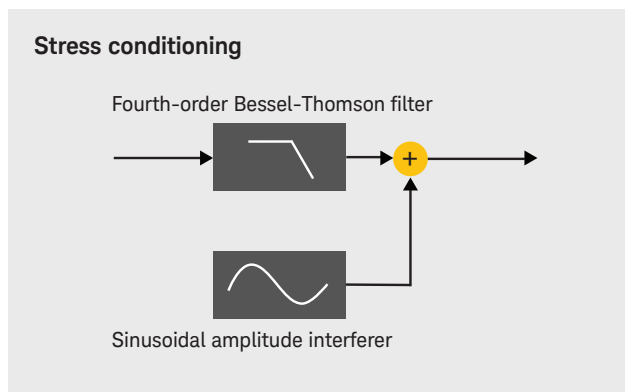

Stress conditioning for 40 GBASE-LR4 and 100 GBASE-LR4, ER4

- Sinusoidal amplitude interferer 1: Causes Sinusoidal Jitter (SJ) in conjunction with limiter
- Gaussian noise generator: Causes Random Jitter (RJ) in conjunction with limiter
- Limiter: Restores signal edges (fast rise and fall times)
- Sinusoidal amplitude interferer 2: Causes additional Vertical Eye Closure (VECP) and Sinusoidal Jitter (SJ)
- Low-pass filter: Creates ISI-induced Vertical Eye Closure (VECP)

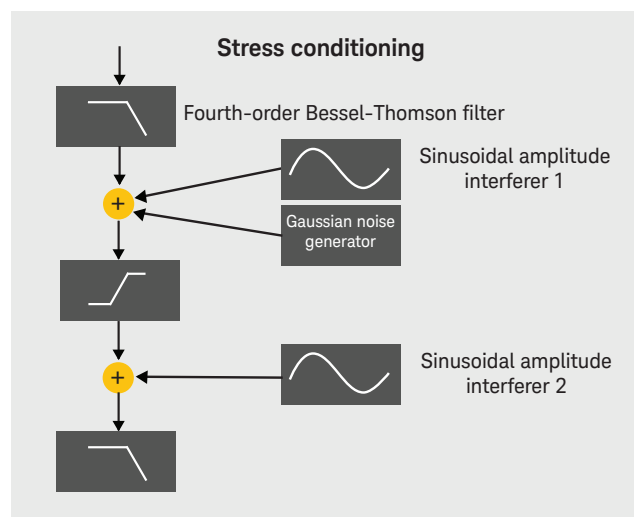

Stress conditioning for 16 GFC

- Coaxial cable: Causes Deterministic Jitter (DJ) in conjunction with limiter
- Limiter: Restores signal edges (fast rise and fall times)
- 4th Order Bessel Thomson Filter: Creates ISI-induced Vertical Eye Closure (VECP)

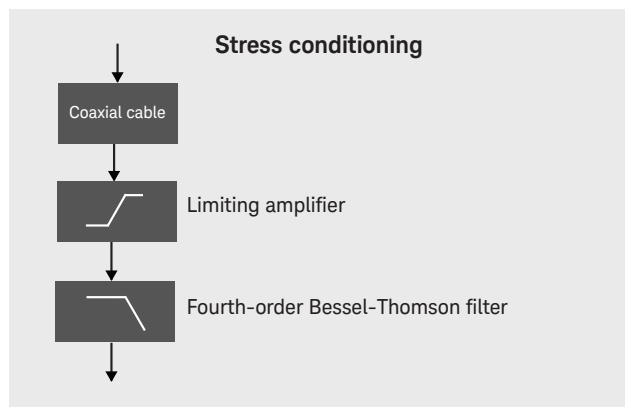

Reference transmitter conditioning setup

This setup varies depending on the speed class and number of lanes. For single lane setups it is just an E/O converter and an optical attenuator. For multi-lane applications, it gets more complicated.

WDM conformance testing 40 Gbase, 100 Gbase -LR4, -ER4

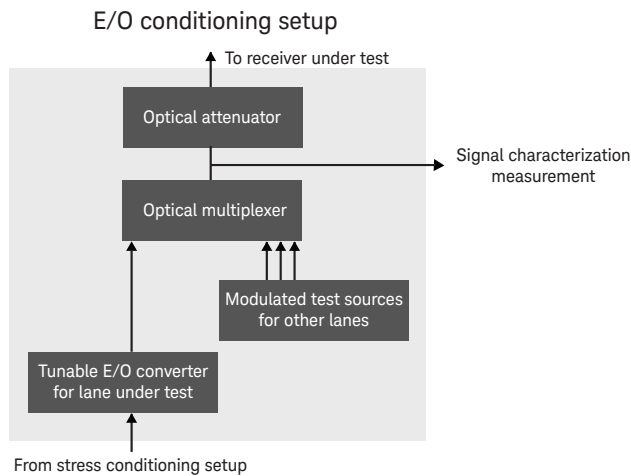

Signal characterization measurement

Test signal calibration and verification

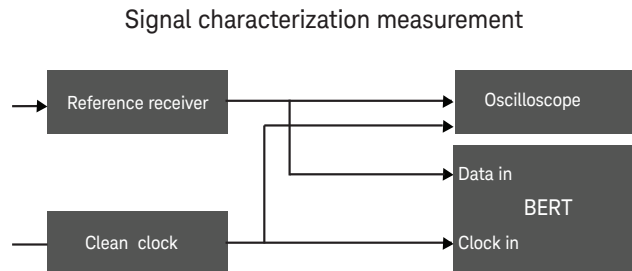

Reference receiver:

Optical to electrical converter with 4th Order Bessel Thomson response and reference frequency f_t of:

$f_t = 7.5$ GHz for 8 GFC

$f_t = 11.0$ GHz for 16 GFC

$f_t = 7.5$ GHz for 40 Gbase-LR4

Oscilloscope:

Use clean, un-jittered clock to verify stressed signal.

Tunable E/O converter for selecting stressed lane under test:

Modulated with stressed test signal.

OMA set to „stressed receiver sensitivity spec“.

- Wavelength (λ) tuned to corresponding worst-case sensitivity of RXuT
- Or fixed wavelength (λ) in specified range of RXuT

Modulated test sources for other lanes:

Modulated simultaneously with valid standard pattern.

- OMA set to highest „difference in receive power spec“.
Wavelength (λ) tuned to corresponding worst-case crosstalk to lane under test.
- OMA set to highest „difference in receive power spec“ plus increment of loss variation of lane under test, plus increment of isolation variation to lane under test.
Fixed wavelength (λ) in specified range of RXuT

Optical receiver devices, especially those for data rates in the higher Gbps-range, are commonly exposed to extensive stressed receiver sensitivity tests during their design and qualification phase to verify their performance and to determine their margin against the requirements. The BER is measured under standard compliant stressed conditions at various optical modulation amplitudes (OMA) to BER down to 10^{-12} or lower. In the manufacturing phase, BER tests are performed at a few different OMA points down to only BER of 10^{-9} to reduce test time and cost. Applying this reduced test scheme in series implies that the device manufacturer knows very well the device margins. This leads to the requirements for a test solution with high accuracy and reproducibility regarding the stressed test signal generation. For the optical part of the stressed signal generation, this means maintaining high signal fidelity. This demand may lead especially for multimode fiber devices to some interesting test challenges. This catalog covers the test equipment needed to perform these tests.

Get more detail about Keysight's N4917B Optical Receiver Stress Test Solution here in this catalog.

Optical I-Q diagram

The I-Q diagram (also called a polar or vector diagram) displays demodulated data, traced as the in-phase signal (I) on the x-axis versus the quadrature-phase signal (Q) on the y-axis.

This tool gives deeper insight into the transition behavior of the signal, showing overshoot and an indication of whether the signal is bandwidth limited when a transition is not close to a straight line.

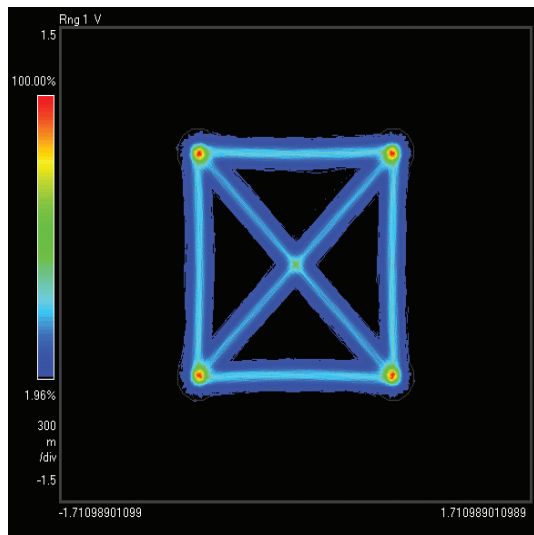

Optical constellation diagram

In a constellation diagram information is shown in a two-dimensional polar diagram, displaying amplitude and phase of the signal. The constellation diagram shows the I-Q positions that correspond to the symbol clock times. These points are commonly referred to as detection decision-points, and are called symbols. Constellation diagrams help identify such things as amplitude imbalance, quadrature error, or phase noise.

The constellation diagram gives fast insight into the quality of the transmitted signal as it is possible to see distortions or offsets in the constellation points. In addition, the offset and the distortion are quantified as parameters for easy comparison to other measurements.

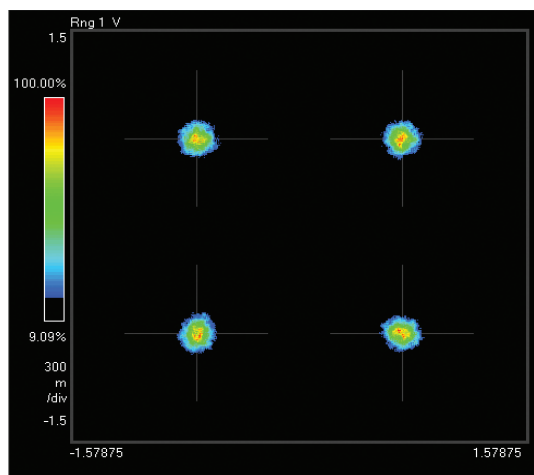

Symbol table/error summary

This result is one of the most powerful tools in the digital demodulation tools. Here, demodulated bits can be seen along with error statistics for all of the demodulated symbols.

Modulation accuracy can be quickly assessed by reviewing the rms EVM value. Other valuable parameters are also reported as seen in the image below.

- Frequency error
- I-Q offset
- Quadrature error
- Gain imbalance

D: Ch1 QPSK Syms/Errs					
EVM	= 406.72	m%rms	867.11	m%pk at sym	83
MagErr	= 278.60	m%rms	717.38	m%pk at sym	47
Phase Err	= 161.24	mdeg	-419.13	mdegpk at sym	89
Freq Err	= 78.400	kHz	SNR(MER)	= 48.261	dB
IQ Offset	= -69.771	dB	Rho	= 0.99998	
QuadErr	= 23.806	mdeg	Gain Imb	= 0.008	dB
0	10000111	10000111	10000111	10000111	10000111
64	10000111	10000111	10000111	10000111	10000111
128	10000111	10000111	10000111	10000111	10000111
192	10000111	10000111	10000111	10000111	10000111
256	10000111	10000111	10000111	10000111	10000111

Eye-diagram of I or Q signal

An eye-diagram is simply the display of the I (real) or Q (imaginary) signal versus time, as triggered by the symbol clock. The display can be configured so that the eye-diagram of the real (I) and imaginary (Q) part of the signal are visible at the same time.

Eye-diagrams are well-known analysis tools in the optical ON/OFF keying modulation analysis. Here, this analysis capability is extended to include the imaginary part.

This tool allows comparison of I and Q eye openings, illustrating possible imbalances very quickly.

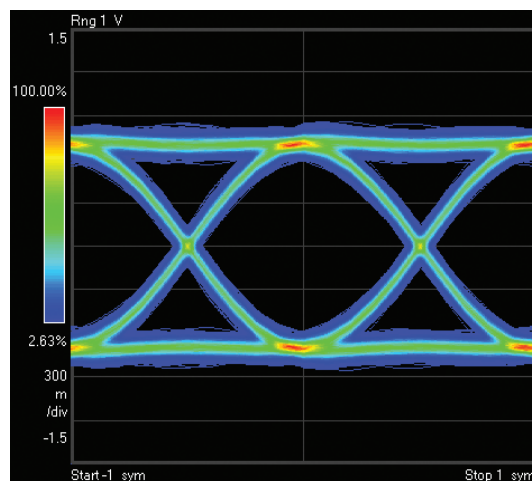

Error vector magnitude

The error vector time trace shows computed error vector between measured I-Q points and the reference I-Q points. The data can be displayed as error vector magnitude, error vector phase, the I component only or the Q component only.

This tool gives a quick visual indication of how the signal matches the ideal signal.

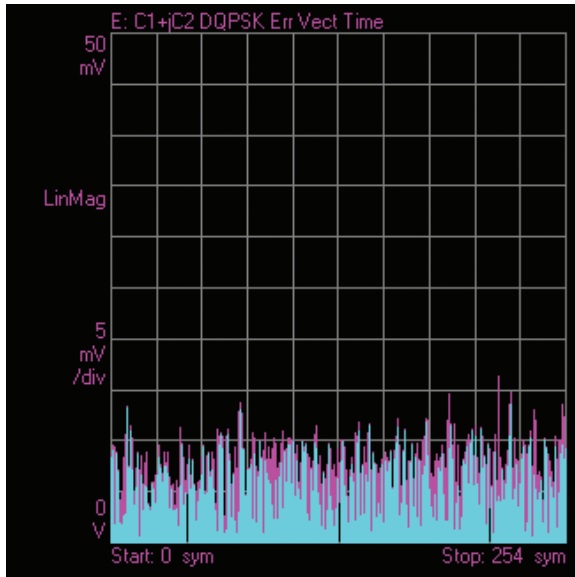

Error vector limit test

The error vector concept is a very powerful way to qualify the overall performance of an complex modulated signal. Testing against a limit with pass/fail indication covers all typical error sources that could occur during transmitter manufacturing, alignment or along a link.

While deploying a new link operating with complex modulated signals, the pass fail test is an easy-to-use and powerful tool to test the physical layer signal quality against a defined limit. Having a physical layer signal in the desired quality is a prerequisite for well performing higher layer protocols.

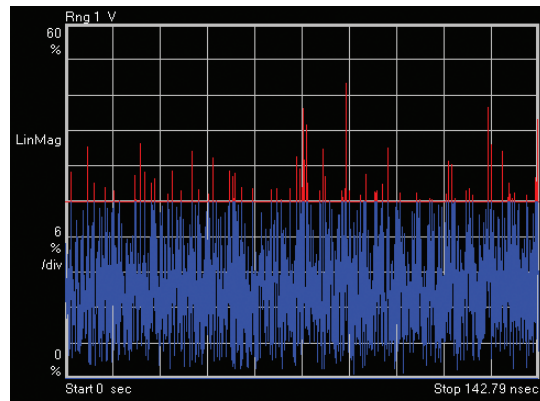

$$EVM [n] = \sqrt{I\ err [n]^2 + Q\ err [n]^2}$$

Where [n] = measurement at the symbol time
 $I\ err = I\ reference - I\ measurement$
 $Q\ err = Q\ reference - Q\ measurement$

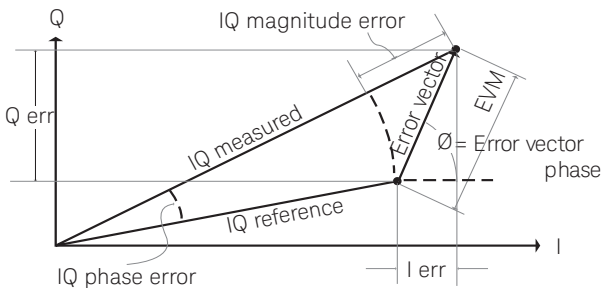

Bit/Symbol/Error analysis

Beside the wide variety of physical parameters that can be analyzed, the optical modulation analyzer also offers the bit and symbol error analysis. Being able to detect the transmitted symbols and bits, enables comparison of the measured data against the real transmitted data.

With PRBS of any polynomial up to 2^{31} and the option for user defined patterns, the optical modulation analyzer is able to actually count the symbol errors and measure the bit error ratio during a burst.

Having these analysis tools, it is now very easy to identify the error causing element, – transmitter, link or receiver – if a classic electrical point to point BER test fails.

In addition this feature offers the option to perform a stress test on a receiver, by exactly knowing the quality of the receiver input signal and being able to compare to the overall BER of the system.

www.keysight.com/find/n4392a

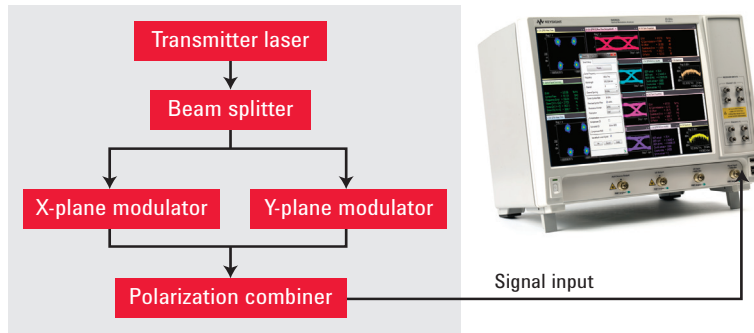

Transmitter signal integrity characterization

- Transmitter signal performance verification
- Verify optimal alignment biasing circuits and skews
- Transmitter vendor qualification
- Final pass fail test in manufacturing
- Evaluation of transmitter components for best signal fidelity

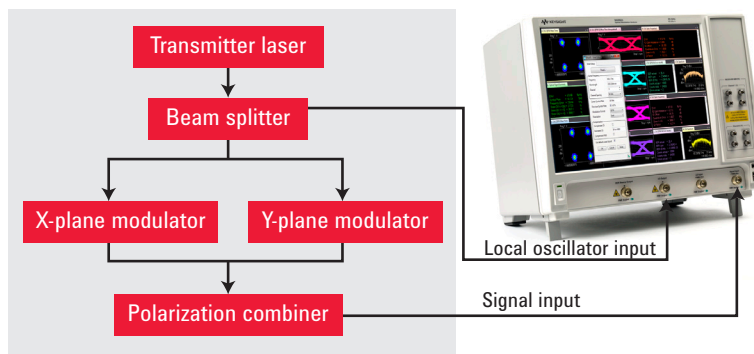

Homodyne component characterization

- Component evaluation independent of carrier laser phase noise
- Modulator in system qualification
- Modulator in-application verification
- Advanced debugging to detect hidden transmitter issues

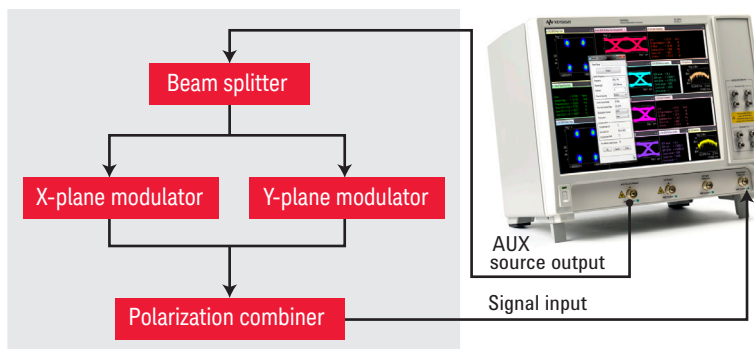

Component evaluation

- Cost effective modulator evaluation
- Cost effective modulator driver evaluation
- Final specification test in application of IQ modulator
- Homodyne testsetup to evaluate influence of phase noise

Applications

Coherent Transmitter Test

www.keysight.com/find/oma

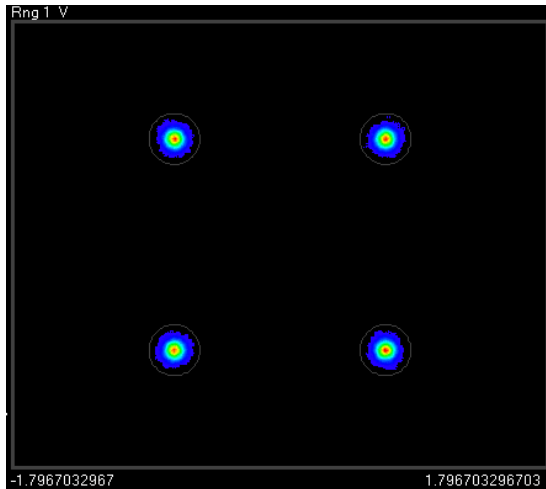

Optical constellation diagram

In a constellation diagram, signal information is shown only at the middle of a symbol time. This represents exactly the time stamp a real receiver will take to decide on the transmitted data. These points are commonly referred to as detection decision-points-, and are interpreted as the digital symbols. Constellation diagrams help identify effects like amplitude imbalance, quadrature error, or phase noise just to mention some of them.

For calculating the BER based on statistical data a Gaussian noise distortion is required in the same way as for Q factor based BER calculation. The color coded display option gives a fast indication if this requirement for BER calculation based on noise statistics is fulfilled.

For complex modulated signals the statistic BER is calculated based on the EVM calculation of the software.

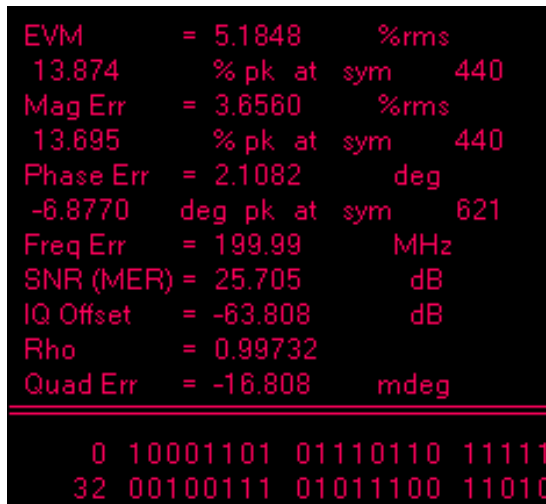

Symbol table/error summary

This result table is one of the most powerful tools of the vector analysis software. With just a few scalar parameters you can get full insight in your transmitter quality and in addition get an indication on the most likely error source in coherent optical transmitter.

The following list describes these parameters briefly:

- EVM to check overall transmitter signal distortions including noise
- I-Q offset for checking transmitter alignment
- Quadrature error to verify 90 degree bias point alignment in transmitter modulator
- Gain imbalance between I and Q signal path in transmitter (not displayed here)
- Signal to noise ratio based on EVM measurements

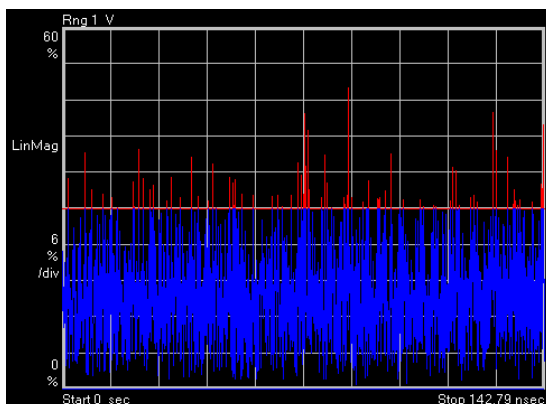

EVM limit test

Error vector magnitude (EVM) is described as a scalar by calculating the rms value of the error vector of all measured symbols within one burst of data recording. A good transmitter shows a white noise like error vector distribution along all symbols. The limit test functionality can detect any violation of a customer definable value and display this in different colors on the screen as shown in figure left. In addition a fail indication is provided by the software. For manufacturing purposes this can be controlled and queried via the easy to use SCPI software interface.

www.keysight.com/find/oma

Customer configurable generic OFDM demodulator

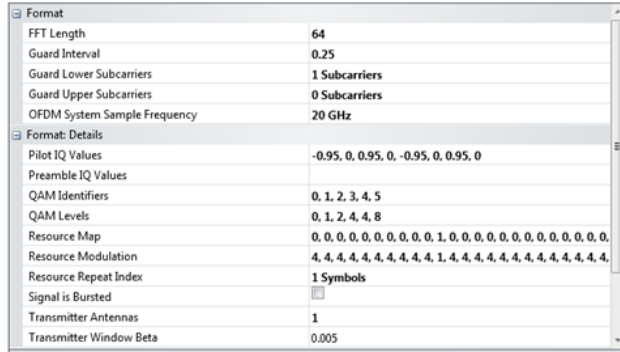

OFDM is a very complex modulation scheme as it distributes the information not only over time with sequential vectors but also over frequency via a customizable number of subcarriers. Each subcarrier can have a different modulation format. In addition in most cases pilot tones need to be detected for synchronization. With this custom configurable OFDM decoder nearly every variation of a digital OFDM signal can be set up and then detected and analyzed in various ways. Some examples are shown below.

	Ch1	Ch2	Ch3	Ch4	Avg
EVM	5.0314	***	***	***	5.0314
EVMPeak	23.163	***	***	***	23.163
PilotEVM	3.7636	***	***	***	3.7636
DataEVM	5.0992	***	***	***	5.0992
PmbIEVM	***	***	***	***	***
FreqErr	***	***	***	***	-279.9
SymClkErr	0.22455	***	***	***	0.2245
CPE	2.1757	***	***	***	2.1757
SyncCorr	***	***	***	***	99.819
IQOffset	-27.492	***	***	***	-27.49
IQQuadErr	0.01842	***	***	***	0.0184
IQGainImb	-0.0030	***	***	***	-0.003
IQTimeSkew	***	***	***	***	***

OFDM error summary

Besides various graphical analysis tools like constellation diagram and EVM over symbols, a detailed error table of relevant error calculations is available. This feature offers the possibility to specify one or more OFDM signal quality parameters at the transmitter output or along the link, which might be useful for transmitter and link performance evaluation.

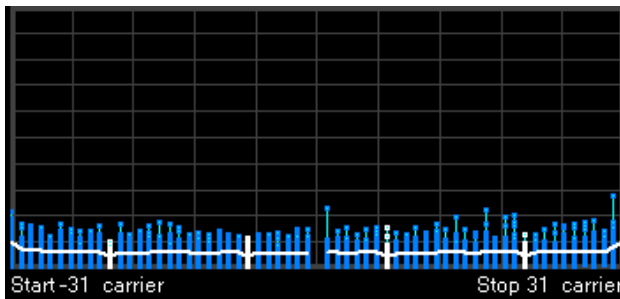

EVM of a symbol

Like in a QPSK or M-QAM signal, an EVM (%rms) value can be calculated for each carrier and displayed along the horizontal axis. This gives an indication of modulation quality on all carriers. The individual bars describe the error vector of each symbol in that carrier, giving additional information about the distribution of the error symbols.

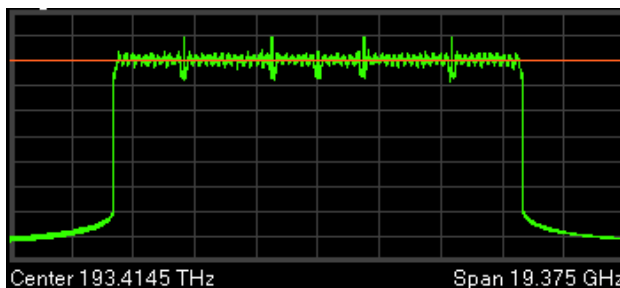

OFDM high resolution spectrum

An OFDM signal is a set of carriers that are orthogonal and very closely spaced in frequency domain, which lets the spectrum appear rectangular in a perfect signal. In addition a OFDM signal often carries pilot and synchronization information at different power levels. With high resolution spectral display, a quantitative analysis of the OFDM signal can be done in parallel with the other analysis tools.

Applications

Research on Modulation Formats

www.keysight.com/find/oma

Customer configurable APSK demodulator

This new generic decoder allows the user to configure a custom decoding scheme in accordance with the applied IQ signal.

Up to 8 amplitude levels can be combined freely with up to 256 phase levels. This provides nearly unlimited freedom in research to define and evaluate the transmission behavior of a proprietary modulation format. The setup is easy and straightforward. Some examples are shown below.

Ring ID	Enabled	# States	Relative Magnitude	Phase
0	<input checked="" type="checkbox"/>	1	0	0 deg
1	<input checked="" type="checkbox"/>	1	0	0 deg
2	<input checked="" type="checkbox"/>	1	0	0 deg
3	<input checked="" type="checkbox"/>	1	0	0 deg
4	<input checked="" type="checkbox"/>	1	0	0 deg
5	<input checked="" type="checkbox"/>	1	0	0 deg
6	<input checked="" type="checkbox"/>	1	0	0 deg
7	<input checked="" type="checkbox"/>	1	0	0 deg

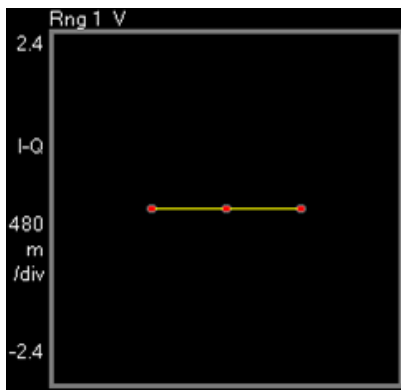

Optical duobinary decoder

In 40 G transmission systems, an optical duobinary format is often used. In order to test the physical layer signal at the transmitter output or along a link, the analysis software now supports this commonly used optical format.

A predefined setting that has a preconfigured optical duo binary decoder is part of the instrument and the analysis software.

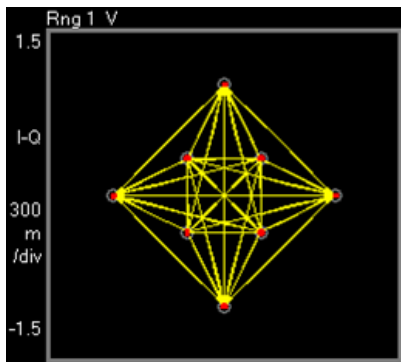

Optical 8 QAM decoder

This example of a coding scheme can code 3 bits per symbol with a maximum distance between the constellation points, providing a good signal to noise ratio.

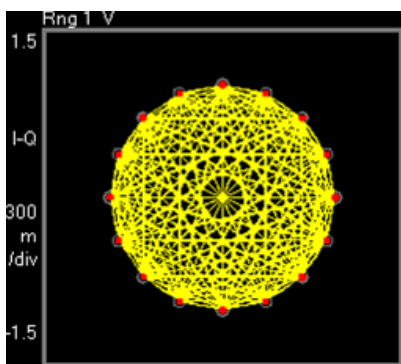

Optical 16 PSK decoder

This is another example of a more complex pure phase modulated optical signal that is sometimes used in research.

With the custom-defined APSK decoder, the same analysis tools are available as in the predefined decoders.

To describe the quality of a complex modulated signal, there are a variety of parameters in place.

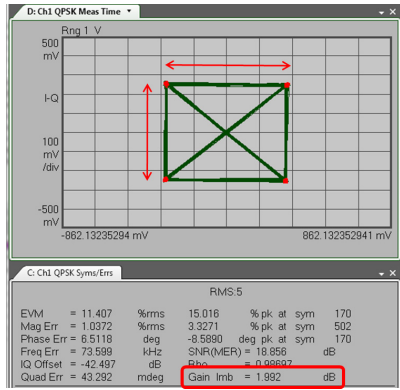

Gain imbalance

Gain imbalance compares the gain of the I signal with the gain of the Q signal and is expressed in dB. The effects of IQ gain imbalance are best viewed in constellation diagrams where the width of the constellation diagram doesn't match its height.

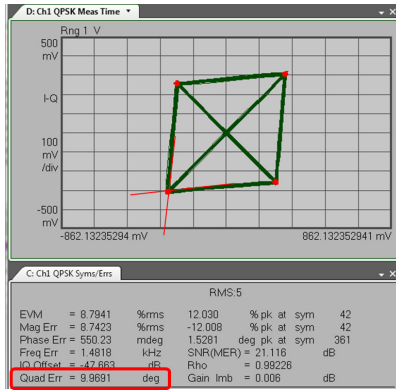

Quadrature error

Quadrature error indicates the orthogonal error between the I and Q Quadrature-Phase. Ideally, I and Q should be orthogonal (90 degrees apart). A quadrature error of -3 degrees means I and Q are 87 degrees apart.

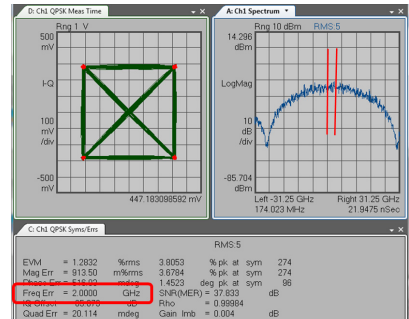

Frequency error

Frequency error shows the carrier's frequency error relative to the local oscillator. This error data is displayed in Hertz and reflects the amount of frequency shift that the instrument must perform to achieve carrier lock.

Note: The frequency error does not influence the error vector magnitude measurement.

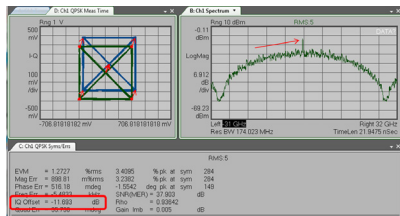

IQ offset

IQ offset (also called I/Q origin offset) indicates the magnitude of the carrier feed through signal. When there is no carrier feed through, IQ offset is zero (-infinity dB).

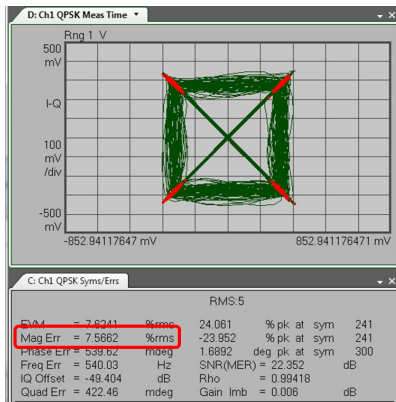

Magnitude error

Magnitude error is the difference in amplitude between the measured signal and the I/Q reference signal.

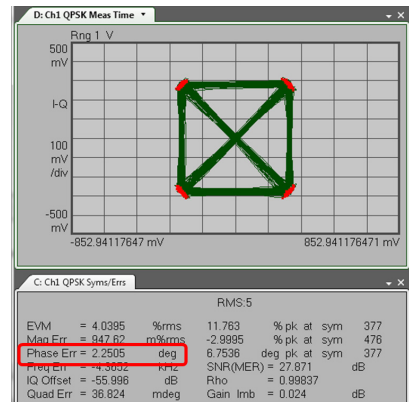

Phase error

Phase error is the phase difference between the I/Q reference signal and the I/Q measured signal, as measured at the symbol time.

www.keysight.com/find/oma

SNR (MER) – signal to noise ratio (modulation error ratio)

SNR (MER) - Signal to Noise Ratio (Modulation Error Ratio) is the signal-to-noise ratio, where signal is the average symbol power of the transmitted waveform. The noise power includes any term that causes the symbol to deviate from its ideal state.

Note: SNR and OSNR are only equal in Gaussian noise limited systems, when proper normalization is used (OSNR is typically measured with 100 pm RBW).

$$SNR = 10 \log \frac{\sum_{n=1}^N (IQ \text{ reference vector at symbols})^2}{\sum_{n=1}^N (\text{error vector at symbols})^2}$$

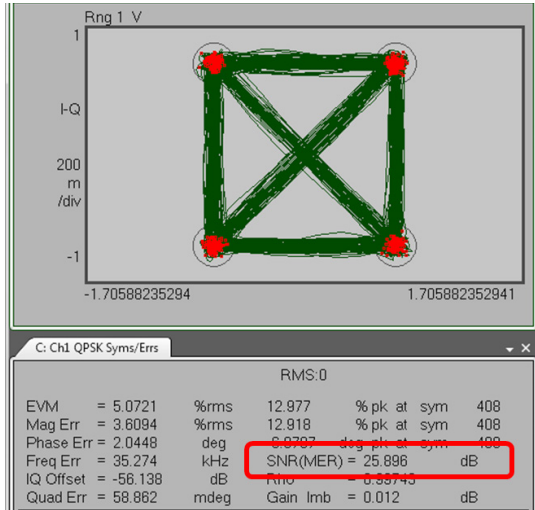

Error vector and error vector magnitude as a global measure

EVM %rms is a normalized measure of all error vectors in the measured data burst. EVM is an excellent indicator summarizing most impairments of a complex modulated signal. Thus a good EVM %rms ensures low impairments including noise are present. Vice versa a bad EVM %rms does not indicate to a distinct impairment parameter. In this case the OMA and the other described parameters help to debug the root cause for worse EVM %rms.

Be aware EVM %rms is not a traceable and standardized parameter therefore it should be used only as relative measure.

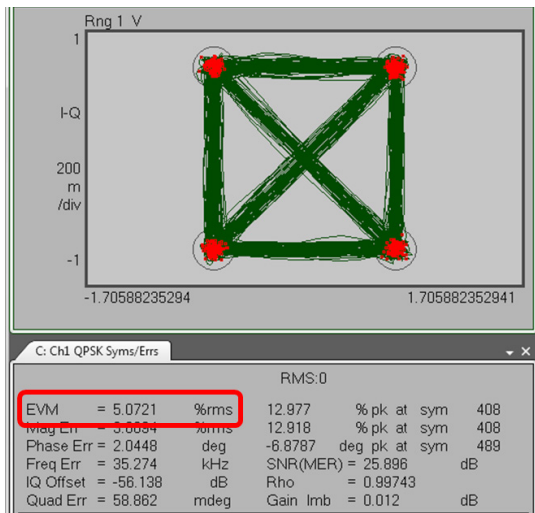

NEW

www.keysight.com/find/oma

The next generation of telecom and datacom transceivers targets a net data throughput of 400 Gbit/s. Depending on the required reach, spectral efficiency and maximum power consumption target, there are different candidates to achieve 400G. With our flexible and scalable solution for a coherent reference transmitter and reference receiver, you can evaluate and develop each of the potential 400G candidates. It comprises:

- A laser to act as the carrier of the optical data signal.
- An arbitrary waveform generator (AWG) for flexible signal generation with 65 GSa/s (M8195A) or 92 GSa/s (M8196A).
- A software (81195A) to generate commonly used complex modulated data signals – The optical modulation generator (OMG).
- A dual-polarization IQ modulator, for example the optical multi format transmitter (OMFT) from ID Photonics that combines the modulator with RF driver amplifiers and an automatic bias controller.
- An optical modulation analyzer (N4391A) to receive and analyze the complex modulated optical data signals.

Below picture shows a setup that combines the reference transmitter with the reference receiver for system performance evaluation. In between, an erbium-doped fiber amplifier (EDFA) and an optical bandpass filter are connected. Individual parts of the system can then be replaced by your device under test to determine its contribution to the overall system performance.

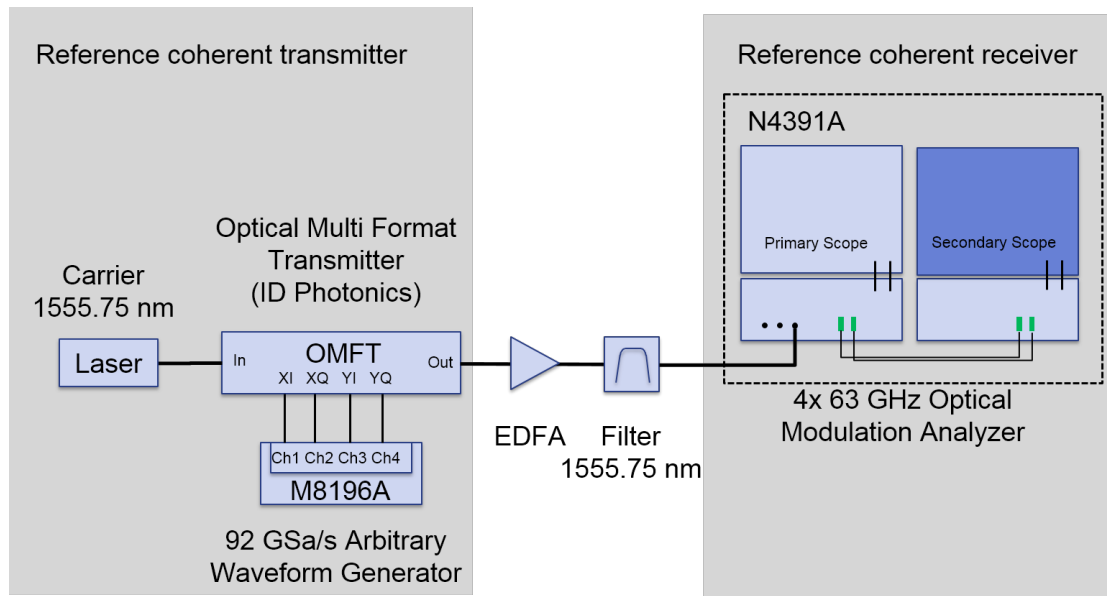

Two examples for 400G signals created and analyzed with the setup shown above

- 64 GBd PDM-16QAM
- Line rate: 512 Gbit/s (20% FEC)
- Fits into 75 GHz ITU slot
- Medium reach: ~1000 km
- C-Band capacity: ~26 Tbit/s
- 43 GBd PDM-64QAM
- Line rate: 512 Gbit/s (20% FEC)
- Fits into 50 GHz ITU slot
- Short reach: ~100 km
- C-Band capacity: ~40 Tbit/s

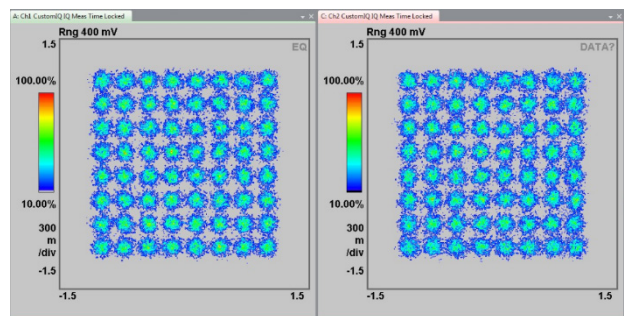
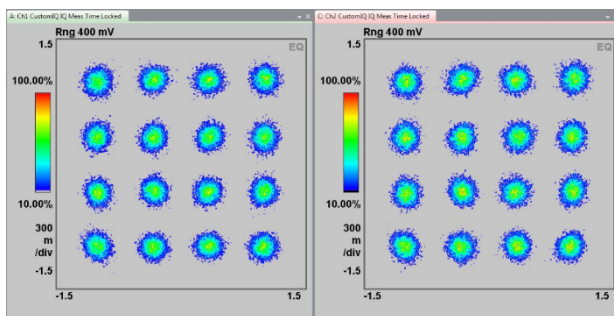

Applications

Optimizing Manufacturing Test Cost

www.keysight.com/find/dcac

Introduction

Manufacturers of optical transceivers are faced with increasing challenges to their businesses, particularly how to reduce product cost. Pressures to reduce cost as data rates rise means manufacturing engineering managers and their engineers must be more creative in how to reduce costs before their competitors do. Traditional methods of eliminating tests or trying to make tests run faster may not be feasible, may not yield the intended benefit or may provide results that don't agree well with their customer's measurements. The use of parallel testing promises huge improvements, but more innovation is needed. Read below, how Keysight helps to optimize the manufacturing processes of optical components.

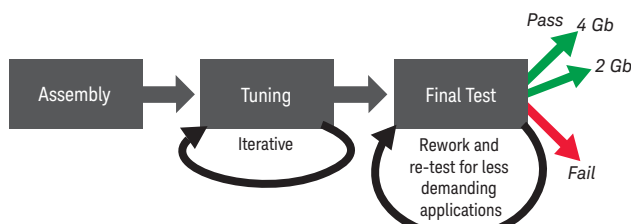

Typical manufacturing flow for simpler and less expensive devices.

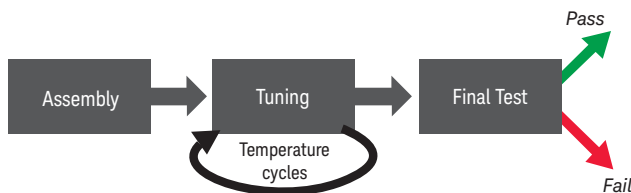

Typical manufacturing flow for more complex devices.

Common transceiver types and manufacturing flows

The number of communications standards and transceiver types has proliferated during the last decade creating more complexity for the typical manufacturing test facility. Mass market and other high volume transceivers typically have fewer tests and less temperature cycling. More complex transceivers at higher data rates have more extensive tuning, temperature cycling and challenges to meet high desired yields.

The ultimate goal of Keysight's approach is to provide a sufficiently accurate answer, very quickly, which is enabled by these recently introduced capabilities:

- DCA with parallel characterization of multiple devices, or characterization of parallel optics, Improved autoscale performance, eye tuning, rapid eye, faster eye mask testing
- Multi-channel BERTs for characterizing multi-channel devices and multi-channel standards (4 x 25 G)
- Great improvements in cost of test are achieved by testing multiple transceivers in parallel, either several single channel transmitters at once or several channels on a multi-channel transmitter
- Multi-port optical attenuator with up to four separate attenuators that are settable in parallel and provide fast settling times, a significant improvement in both multi-device and multi-lane testing
- Newly designed attenuation devices that ensure high modal fidelity in multimode fiber based transceiver testing, a contribution to narrower test margins and thus better yield

Implementing these innovations in your production line can improve by 2X to 10X the number of units tested per station per year, and result in a 2X to 5X improvement in the cost-of-test per transmitter.

Characteristics for common optical communications standards

Standards	Package types	Channel rates, Gb/ s	Optical transmitters
<ul style="list-style-type: none"> - 4X Fiber Channel - SONET/SDH to OC-48 - Gigabit Ethernet - Wireless CPRI - Passive optical network 	SFP, SFF and PON	0.155 to 6.25	1
<ul style="list-style-type: none"> - 16G Fibre Channel - 10 Gb and 40 Gb Ethernet 	SFP+ and XFP	4 to 14	1
<ul style="list-style-type: none"> - 10 Gb, 40 Gb and 100 Gb Ethernet - 32G Fibre Channel - SONET OC-192 	QSFP, and CFP	10 to 29	4, 8, 10, 12
<ul style="list-style-type: none"> - 400 Gb Ethernet - 64G Fibre Channel 			



For 16x Fibre Channel (16 GFC) for transceiver testing

There are three topologies in this type of network including point-to-point, arbitrated loop, and switched fabric. The connections between devices use transceivers for optimization. For example, in a switched fabric topology, SFP+ (8 GFC and 16 GFC), XFP (10 Gb/s) and SFP (≤ 4 Gb/s) are types of transceivers that connect between the switched fabric and various devices such as storage and computing equipment. Typical patterns used to test transceiver devices include PRBS series, JSPAT, and K28 series which are part of the preloaded library of patterns in the N4960A 32 G BERT.

For 16 GFC applications (14.025 Gb/s), the N4960A can perform BER measurements and can provide a stressed pattern generator signal for receiver tests. 16 GFC devices must be accurately characterized to strict tolerances. The N4960A, used with the N4980A multi-instrument BERT software, can also provide jitter tolerance tests for accurate characterization.

A basic configuration using the 17 Gb/s BERT system is shown above. N4951A-P17 and N4952A-E17 can be loaded with common stress patterns for 16 GFC. You can also custom design your own patterns up to 8 Mb in length and upload them into the N4951A-P17 and N4952A-E17.

The figure above shows a typical hardware setup followed by a procedure showing settings for performing a BER test.

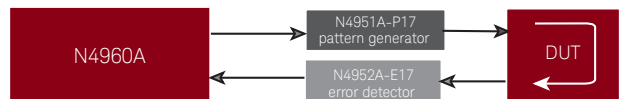

Test setup for 16 GFC

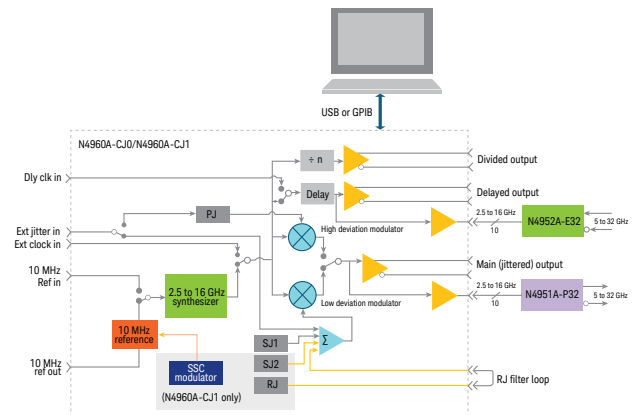

Block diagram (32 Gb/s system)

Applications

Communications Waveform Measurements

www.keysight.com/find/dcax

Application overview

For any high-speed communications signal, the channel and basic signal characteristics must be assessed for compliance with standards and interoperability with other devices in the system path. Digital Communications Analyzers (DCA's) based on wide bandwidth sampling oscilloscopes are recognized as the industry standards for accurate analysis of optical waveforms in R&D, device validation and volume transceiver manufacturing. In addition to basic eye-diagram and pulse waveform characterization, DCA's perform advanced jitter analysis and channel impedance characterization.

Transmitter compliance testing and eye-diagram analysis

Viewing the eye-diagram is the most common method to characterize the quality of a high-speed digital transmitter signal. Industry standards such as SONET, SDH, Fibre Channel and Ethernet rely on eye-diagram analysis to confirm transmitter specifications. The eye is examined for mask margin, amplitude, extinction ratio and overall quality. Tests are commonly performed using a well defined reference receiver to provide consistent results both in manufacturing test, incoming inspection, and system level applications. Standards based reference receivers and test procedures are built into the DCA's to provide compliance test capability.

In these standard tests automatic histogram analysis determines signal levels to derive key waveform parameters including but not limited to:

- Extinction ratio: How efficiently laser power is converted to information power
- Optical modulation amplitude (OMA): A measure of modulation power
- Eye height and width: An indication of how open the eye is
- One and zero levels: The logic levels of the eye
- Signal to noise ratio: Signal strength compared to noise
- Duty cycle distortion and crossing percentage: A measure of eye symmetry

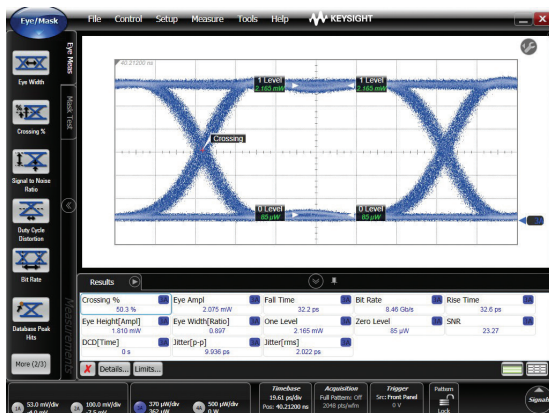

Parameters are automatically derived from the eye-diagram

For eye mask testing industry defined masks are compared to the transmitter eye-diagram. Pass/Fail is quickly determined. Mask margins can be automatically determined. Eye mask test to industry defined hit ratios (a relatively new concept defined as the allowed number of hits compared to the total number of waveform samples) is also automatically performed. Eye mask tests are almost always performed using a reference receiver. A reference receiver defines the entire measurement system to have a specific low pass frequency response, the most common being a fourth-order Bessel low-pass response with the -3 dB frequency at 75% of the data rate.

For example, a 10 Gb/s reference receiver would have a 7.5 GHz bandwidth. A reference receiver allows the waveform to be viewed closer to what a receiver in an actual communications system would see.

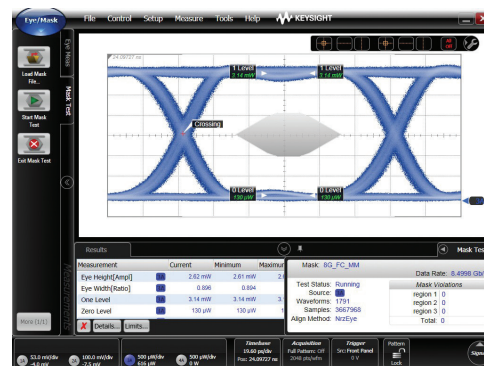

Eye mask tests are performed with a reference receiver based test system

Newer industry standards also employ multi-level signaling formats such as Pulse Amplitude Modulation 4-Level (PAM4). Existing DCA hardware can be used together with new PAM4 Analysis software to analyze optical and electrical PAM4 signals quickly and accurately. Key optical PAM4 parameters characterized by the DCA include:

- Transmitter dispersion and eye closure penalty (TDECQ)
- Outer optical modulation amplitude (Outer OMA)

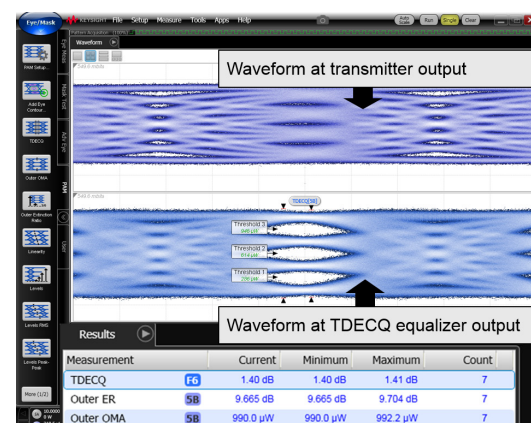

PAM4 analysis software quickly and accurately performs key optical measurements such as TDECQ, Outer OMA, and ER.

www.keysight.com/find/dcac

Waveform measurements

Not all waveform measurements of optical signals are performed with a reference receiver. The filtering can be switched out to provide a wider bandwidth measurement system. The unfiltered properties of the waveform are accurately observed. The transmitter output may be viewed as an unfiltered eye, or as a pulse train depending on how the DCA is triggered. A DCA can be placed in 'pattern lock' mode to view the individual bits of a digital communications signal allowing a simple analysis of the waveform quality including parameters such as rise and fall times, pulsewidth and overshoot. In 'pattern lock' mode a complete single-valued waveform record, up to 2^{23} bits long, can be recorded for off-line analysis. Advanced signal processing is available with the 86100D (see pages 31 to 36).

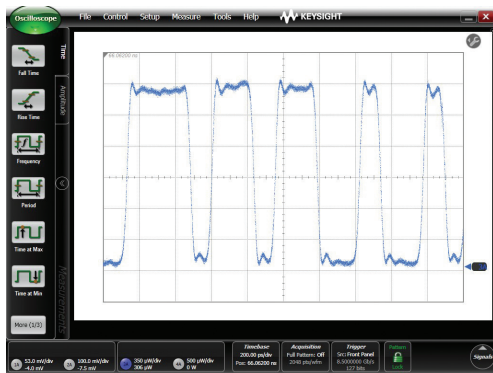

Individual bits can be observed in a 'pattern lock' display

Typically an external timing reference is used to synchronize the oscilloscope to the test signal. In cases where a trigger signal is not available or when required for a standards compliance measurement, clock recovery modules or clock recovery instruments are available to derive a timing reference directly from the waveform to be measured. Clock recovery not only provides a convenient method to synchronize the oscilloscope, it can also control the amount of jitter displayed. Clock recovery effectively creates a high-pass effect in the jitter being observed on the oscilloscope. The clock recovery system loop bandwidth defines the filtering range (see Keysight Product Note 86100-5).

Jitter analysis

Every high-speed communications design faces the issue of jitter. When data are jittered from their expected positions in time, receiver circuits can make mistakes in trying to interpret logic levels and BER is degraded. As data rates increase, jitter problems tend to be magnified. For example, the bit period of a 10 Gb/s signal is only 100 picoseconds. Signal impairments such as attenuation, dispersion and noise can cause the few picoseconds of timing instability to create eye closure that can mean the difference between achieving or failing to reach BER objectives. The problem is further aggravated by the difficulty presented in making accurate measurements of jitter. A variety of measurement approaches exist but there has been frustration within the industry around the complexity of setting up a measurement, getting repeatable results and the inconsistency of different techniques.

The "equivalent time" sampling oscilloscope, with configurations having over 80 GHz of bandwidth and extremely low levels of intrinsic jitter, is the most accurate tool available for jitter measurements at high data rates.

In many communications systems and standards, specifying jitter involves determining how much jitter can be on transmitted signals. Jitter is analyzed from the approach that for a system to operate with very low BER's (one error per trillion bits being common), it must be characterized accurately at corresponding levels of precision. This is facilitated through separating the underlying mechanisms of jitter into classes that represent root causes. Specifically, jitter is broken apart into its random and deterministic components. The deterministic elements are further broken down into a variety of subclasses. With the constituent elements of jitter identified and quantified, the impact of jitter on BER is more clearly understood which then leads to straightforward system budget allocations and subsequent device/component specifications. Breaking jitter into its constituent elements allows a precision determination of the total jitter on a signal, even to extremely low probabilities.

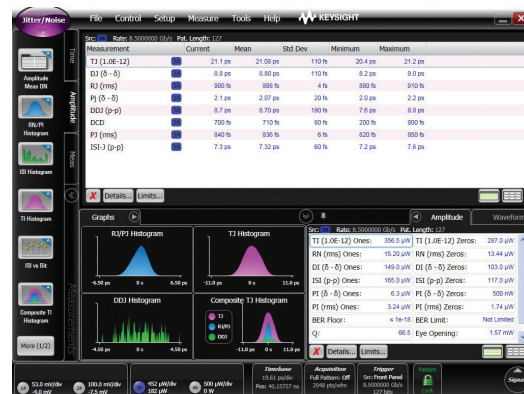

Advanced analysis identifies sources of jitter

Time domain reflectometry and transmission

Most optical devices have high-speed electrical input and output paths. High signal integrity is achieved with well designed signal paths. DCA's can also be configured as time domain reflectometers (TDR) to easily determine the transmission and reflection properties of electrical channels. This information can be presented as a function of time or frequency as S-parameters. Most new circuit designs are differential to improve crosstalk and interference performance. Circuits need to be characterized in single-ended, differential signal and common signal configurations.

The TDR module sends a fast edge along the transmission line, then analyzes the reflected signal and displays voltage or impedance versus distance. This information can also be converted into the frequency domain to display return loss, VSWR or reflection coefficient versus frequency. Any selected portion of the trace can also be assessed for the excess inductance or capacitance, allowing the designer to estimate the amount of required compensation in that region.

NEW

Addressing the next challenges

The next generation computer and communication systems now being developed will handle data rates of hundreds of gigabits/second. Many systems will incorporate processors and SERDES chip sets that exceed GigaHertz clock frequencies.

New and troubling input/output issues are emerging as switches, routers, server blades, and storage area networking equipment moving toward 100 Gbps data rates. Digital design engineers choosing chip-to-chip and backplane technologies for these systems are finding signal integrity challenges that have not been encountered before.

The problem with traditional parallel bus topologies

Traditional parallel bus topologies are running out of bandwidth. As parallel busses become wider, the complexity and cost to route on PC boards increase dramatically.

The growing skew between data and clock lines has become increasingly difficult to resolve within parallel busses.

The solution is fast serial channels

The newer serial bus structure is quickly replacing the parallel bus structure for high-speed digital systems. Engineers have been turning to a multitude of gigabit serial interconnect protocols with embedded clocking to achieve the goal of simple routing and more bandwidth per pin.

However, these serial interconnects bring their own set of problems

In order to maintain the same total bandwidth as the older parallel bus, the new serial bus needs to increase its data rate. As the data rate increases through serial interconnects, the rise time of the data transition from a zero logic level to a one logic level becomes shorter. This shorter rise time creates larger reflections at impedance discontinuities and degrade the eye diagram at the end of the channel.

As a result, physical layer components such as printed circuit board traces, connectors, cables, and IC packages can no longer be ignored. In fact, in many cases, the silicon is so fast that the physical layer device has become the bottleneck.

Move to differential transmission lines

In order to maintain signal integrity throughout the complete channel, engineers are moving away from single-ended circuits and now use differential circuits. The differential circuit provides good Common Mode Rejection Ratio (CMRR) and helps shield adjacent PCB traces from crosstalk. Properly designed differential transmission lines will minimize the undesirable effect of mode conversion and enhance the maximum data rate throughput possible.

Unfortunately, differential signaling technology is not always an intuitive science. Differential transmission lines coupled with the microwave effects of high-speed data have created the need for new design and validation tools for the digital design engineer.

www.keysight.com/find/plts

Understanding the fundamental properties of signal propagation through measurement and post-measurement analysis is mandatory for today's leading edge telecommunication and computer systems. The traditional Time Domain Reflectometer (TDR) is still a very useful tool, but many times the Vector Network Analyzer (VNA) is needed for the complete characterization of physical layer components.

There is a strong need for a test and measurement system that will allow simple characterization of complex microwave behavior seen in high speed digital interconnects.

Frequency domain layer measurements and compliance

In fact, many digital standards groups have now recognized the importance of specifying frequency domain physical layer measurements as a compliance requirement.

Both Serial ATA and PCI Express® have adopted the SDD21 parameter (input differential insertion loss) as a required measurement to ensure channel compliance (Figure 3). This parameter is an indication of the frequency response that the differential signal sees as it propagates through the high-speed serial channel. An example of a proposed SDD21 compliance mask is shown in Figure 5 for the Channel Electrical Interface (CEI) working group for the Optical Internetworking Forum (OIF).

Furthermore, new metrics such as Channel Operating Margin are creating the next generation of compliance testing for the complete channel from TX to RX."

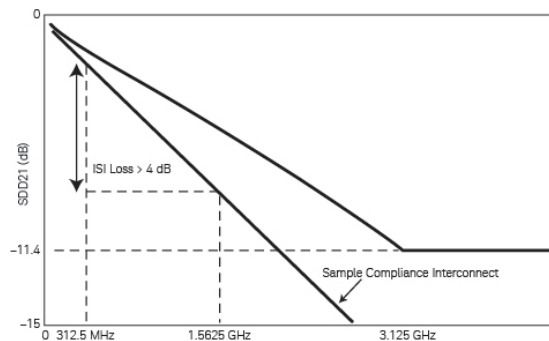

Today's digital standards are now using frequency domain measurements for compliance testing, such as this input differential insertion loss (SDD21) mask for XAU1.

Why is Physical Layer Testing Required? (Cont.)



www.keysight.com/find/plts

A single test system can provide the total view

As the combination of both time-domain and frequency domain analysis becomes more important, the need for multiple test systems becomes difficult to manage. A single test system that can fully characterize differential highspeed digital devices, while leaving domain and format of the analysis up to the designer, is a very powerful tool.

Keysight's Physical Layer Test System (PLTS) is designed specifically for this purpose.

PLTS has been designed specifically for signal integrity analysis. PLTS software guides the user through hardware setup and calibration, and controls the data acquisition. It automatically applies patented transformation algorithms to present the data in both frequency and time domains, in both forward and reverse transmission and reflection terms, and in all possible modes of operation (single-ended, differential, and mode-conversion). A powerful virtual bit pattern generator feature allows a user-defined binary sequence to be applied to the measured data to convolve eye pattern diagrams. Next, highly accurate RLCG 1 models can be extracted and used to enhance the accuracy of your models and simulations.

PLTS provides design confidence through complete characterization

Physical-layer structures have increasingly become the bottleneck in high-speed digital system performance. At low data rates, these interconnects are electrically short. The driver and receiver are typically the biggest contributors to signal integrity. But as clock speeds, bus speeds, and link speeds all push past the gigabit-per-second mark, physical layer characterization becomes more critical.

Another challenge for today's digital designers is the trend to differential topologies. Fully understanding device performance requires analysis in all possible modes of operation.

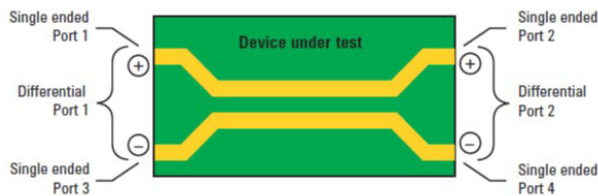

A differential structure operates in many modes. Single-ended analysis can reveal sources of asymmetry on this differential transmission line.

Time-domain analysis is typically used for characterization of these physical-layer structures, but often, the designer concentrates only on the intended modes of operation. For a complete time-domain view, step and impulse responses in reflection and transmission (TDR and TDT) must be seen. The analysis must include the unintended modes of operation as well.

Frequency-domain analysis, again in all possible modes of operation, is also necessary for fully characterizing these physical-layer structures. The s-parameter model describes the analog behavior exhibited by these digital structures. This behavior includes reflections from discontinuities, frequency dependent losses, crosstalk, and EMI performance.

For translating device performance into standards compliance, eye diagrams add an important statistical analysis. And for leveraging this complete characterization into improved simulations, measurement-based s-parameter or RLCG¹⁾ model extraction completes the picture.

Mode	Time domain		Frequency domain	
	TDR	TDT	Reflection	Transmission
Differential	TDD11	TDD21	SDD11	SDD21
	TDD22	TDD12	SDD22	SDD12
Diff-to-comm	TCD11	TCD21	SCD11	SCD21
	TCD22	TCD12	SCD22	SCD12
Comm-to-diff	TDC11	TDC21	SDC11	SDC21
	TDC22	TDC12	SDC22	SDC12
Common	TCC11	TCC21	SCC11	SCC21
	TCC22	TCC12	SCC22	SCC12
Single-ended	T11	T21 T31 T41	S11	S21 S31 S41
	T22	T12 T32 T42	S22	S12 S32 S42
	T33	T13 T23 T43	S33	S13 S23 S43
	T44	T14 T24 T34	S44	S14 S24 S34

Complete characterization includes forward and reverse transmission and reflection, in all possible modes of operation, in both frequency and time domains.

1. An RLCG equivalent circuit model, also known as Telegrapher's Parameters, describes the electrical behavior of a passive transmission line. The model is a distributed network consisting of series resistance and inductance (R and L) and parallel capacitance and conductance (C and G).

NEW

PLTS enables mode-conversion analysis for early insight into EMI problems

The benefits of differential signaling include lower voltage swings, immunity from power supply noise, a reduced dependency on RF ground, and improved EMI performance (reduced generation and susceptibility). The extent to which a device can take advantage of these benefits is directly related to device symmetry.

Symmetric devices

Symmetric devices only respond to, and only generate, differential signals. These ideal devices do not respond to or generate common-mode signals, and they reject radiated external signals (i.e., power supply noise, harmonics of digital clocks or data, and EMI from other RF circuitry).

Asymmetric devices

Asymmetric devices however, do not exhibit these benefits. When stimulated differentially, an asymmetric device will produce a common-mode response in addition to the intended differential response, and cause EMI radiation.

Conversely, with a common-mode stimulus, an asymmetric device will produce an unintended differential response. This mode conversion is a source of EMI susceptibility. Mode-conversion analysis is an important tool for understanding and improving device symmetry, and provides the designer with early insight to identify and resolve EMI problems at the design stage.

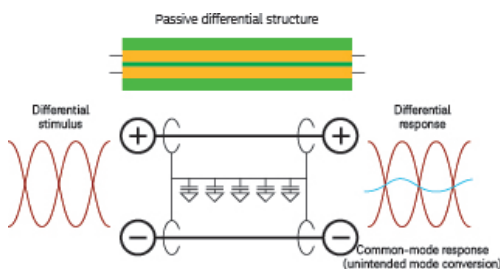

Asymmetric devices cause mode-conversions, which are indicators of EMI generation and susceptibility.

Mode conversion - A practical application

A practical application of how mode conversion helps identify problems in physical layer devices is shown in Figure 7. This shows a XAUI backplane with two daughter cards that typically transmit data at 3.125 Gbps.

The design objective for this high-speed differential channel is to minimize the crosstalk between adjacent differential PCB traces throughout the length of the channel. The channel consists of the linear passive combination of the backplane and two daughter cards. Any mode conversion from differential mode to common mode will generate EMI and create crosstalk that will be incident upon other channels and will degrade performance. However, locating the exact structure within the channel that creates the most mode conversion is not simple.

www.keysight.com/find/plts

Looking at Figure below, the differential to common mode conversion time domain reflection parameter (TCD11) is time aligned with the differential impedance profile of the channel (TDD11) below it. A marker is placed on the largest magnitude peak of TCD11. This is where the physical structure within the channel is creating the most mode conversion and thus the source of the most crosstalk.

We can align the TDD11 to the TCD11 in time and therefore co-locate the problematic structure on TDD11. To relate this structure to the channel, we use the differential impedance profile as a reference. From previous analysis, we know that the two capacitive discontinuities on TDD11 are the daughter card via field and motherboard via field, respectively.

Since the marker falls upon the second discontinuity on TDD11, it is deduced that the motherboard via field is the biggest culprit to causing crosstalk in adjacent channels. The motherboard via field was subsequently rerouted and the crosstalk generation was reduced considerably. This shows how identifying the mode conversion in a channel can be intuitive with proper analysis.

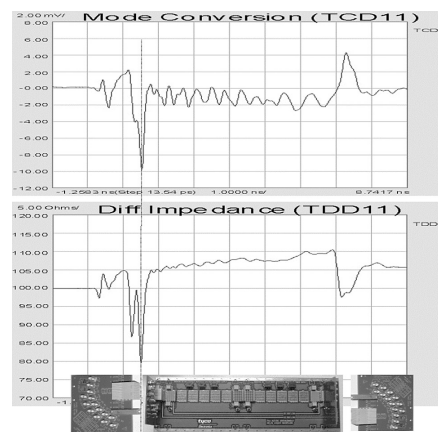

By aligning the impedance profile with the mode conversion profile, PLTS allows the pinpointing of crosstalk-generating structures within physical layer devices.

Remove unwanted effects from the measurement

Error correction

Over the years, many different approaches have been developed for removing the effects of the test fixture from the measurement (shown in Figure 11). The level of difficulty for each error correction technique is linearly related to the accuracy of each method. Time domain gating is perhaps the simplest and most straightforward method, but it is also the least accurate. Likewise, de-embedding is the most complicated method, but it is the most accurate. It is important to have a test system that will allow flexibility of choosing the method of error correction desired for each application.

Error correction techniques fall into two fundamental categories: direct measurement (pre-measurement processing) and de-embedding (post-measurement processing). Direct measurement requires specialized calibration standards that are connected to the end of a coaxial test cable and measured. The accuracy of the device measurement relies on the quality of these physical standards. De-embedding uses a model of the test fixture and mathematically removes the fixture characteristics from the overall measurement. This fixture de-embedding procedure can produce very accurate results.



Various Error Correction Techniques

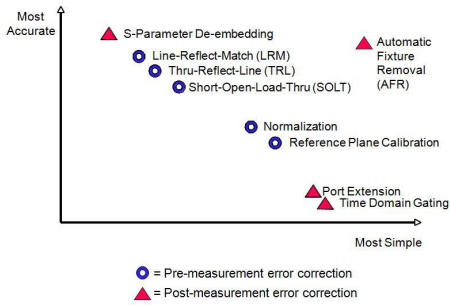

PLTS has advanced error correction techniques to allow flexibility for many applications.

Port Extension

Port Extension (also known as Phase Rotation) mathematically extends the calibration reference plane to the DUT.

This technique is easy to use, but assumes the fixture – the unwanted structure – looks like a perfect transmission line: a flat magnitude response, a linear phase response, and constant impedance. If the fixture is very well designed, this technique can provide good results.

Because gating essentially considers the magnitude of the unwanted discontinuity, and Port Extensions consider phase (electrical length), using the two tools together may provide optimum results.

Because gating essentially considers the magnitude of the unwanted discontinuity, and Port Extensions consider phase (electrical length), using the two tools together may provide optimum results.

Time-domain gating

Time-domain gating (see figure) is similar to port extension, in that it is also very easy and fast. The user simply defines two points in time or distance, and the software mathematically replaces the actual measured data in that section with data representing an “ideal” transmission line. The return loss is then recalculated to show the effects of the change in the frequency domain.

One practical application of time-domain gating is as a confidence check before replacing a suspect connector. Figure 14 illustrates how this technique might be used.

De-embedding (see figure at the right/middle) uses an accurate linear model of the fixture, or measured s-parameter data of the fixture. This fixture data can then be removed mathematically from the DUT measurement data in post-processing.

Calibration at the DUT reference plane has the advantage that the precise characteristics of the fixture do not need to be known beforehand, as they are measured and corrected for during the calibration process.

An example of this technique is microprobing using a calibration substrate, where the calibration reference plane is established at the probe tips, rather than at the end of the coaxial test cables.

Advanced calibration techniques (TRL/LRM) – originally developed for wafer probing applications – provide additional options.

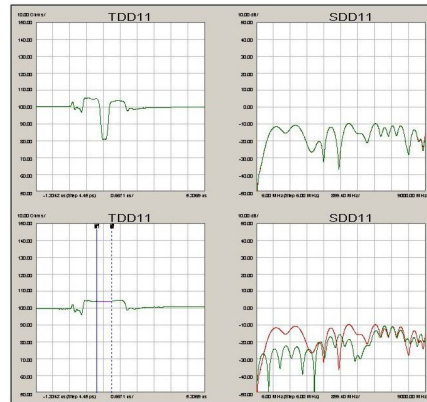

In this rather extreme example of time-domain gating, the top plots show the measured differential step impedance and return loss. The lower left plot shows a gate added to remove the large discontinuity in the center of the trace. On the lower right, the measured and the recalculated return losses are displayed. In this case, the gate improved the return loss by more than 10 dB within the frequency band of interest.

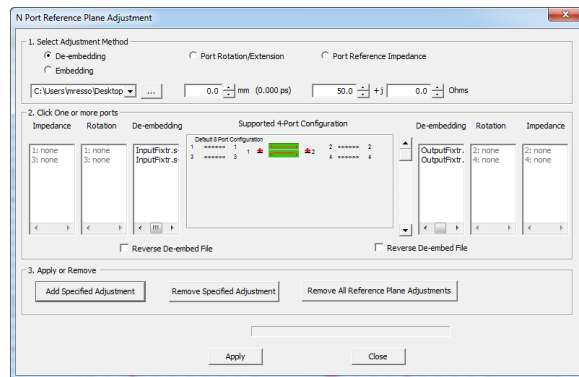

The effects of test fixtures can be removed from the device in post-processing through de-embedding.

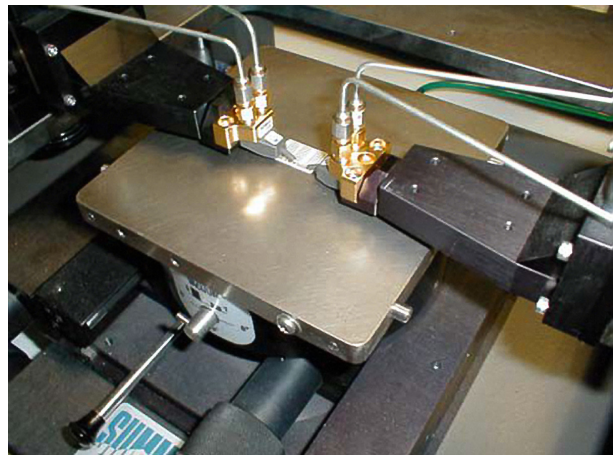

A microprobing application, where the calibration is performed using an impedance standard substrate, establishes the calibration reference plane at the probe tips.

Applications

Lightwave Component Analysis

www.keysight.com/find/lca

In digital photonic transmission systems, the performance is ultimately determined by Bit Error Ratio Test (BERT). As this parameter describes the performance of the whole system, it is necessary to design and qualify subcomponents like modulators and PIN detectors, which are analog by nature, with different parameters that reflect their individual performance.

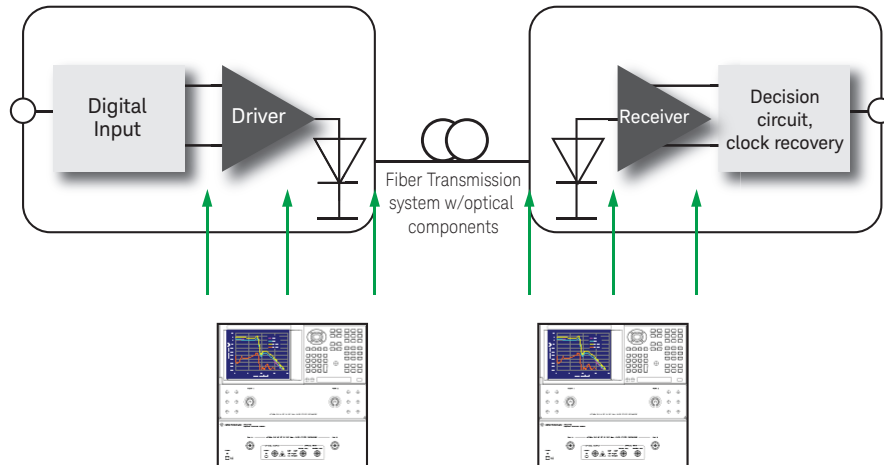

These components significantly influence the overall performance dependant of modulation frequency system with the following parameters:

- 3 dB bandwidth of the electro- optical transmission
- Relative frequency response, quantifying how the signal is transformed between optical and electrical connection
- Absolute frequency response, relating the conversion efficiency of signals from the input to the output
- Electrical reflection at the RF port
- Group delay of the opto-electronic component to qualify the distortion caused by frequency dependent delay

In many cases it is necessary to qualify the lab prototype of a receiver or transmitter for manufacturing. In this case the device under test needs to be characterized under various environmental and operating conditions. With the .NET based remote control this task can be automatized to verify the optimal working conditions of the device. In the following manufacturing process each device can be characterized using this automated control of the LCA via LAN.

O/E characterization

The measurement of an electro-optical receiver device consists of the ratio of output electrical modulation current to input optical modulation power. Responsivity for OE devices described how a change in optical power produces a change in electrical current. Graphically this is shown in the figure below.

The LCA measures the input optical modulation power and output modulation current and displays the ratio of the two in Amps/Watt.

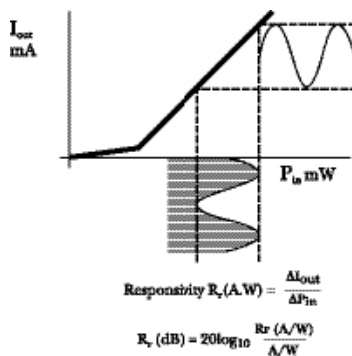

E/O characterization

The measurement process for EO devices is similar to OE devices. The measurement of an EO transmitter is a combination of input modulating current and output optical modulation power. Slope responsivity is used to describe how a change in input current produces a change in optical power. Graphically this is shown in the figure below.

An LCA measures input modulating current and output modulation power and displays the ratio of the two in Watts/Amp, either linearly or in decibels.

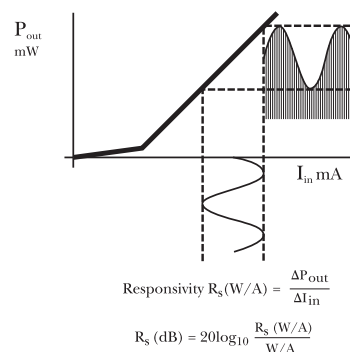

www.keysight.com/find/n7700

The N7700A Photonic application suite

- Display and overlay of traces from multiple channels and multiple measurement files
- Scale switching between wavelength and frequency
- Display of tabular analysis
- Smoothing, markers and zooming
- File loading, saving and data export
- Direct launching of Excel and Matlab with data

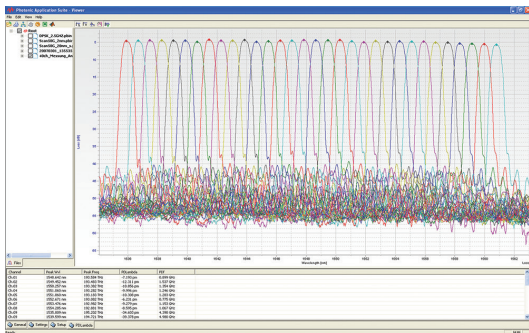

The N7700A Photonic Application Suite is a modular software platform for fast, easy and advanced characterization and analysis of optical components and signals. This suite is widely distributed with instruments and from the Keysight website and can be installed on PCs to control instruments and to process and analyze measurement data.

The freely-distributed main package of the N7700A Photonic Application Suite provides a powerful File Viewer program that allows viewing and analyzing measurement data. It has been designed for sharing measurement results throughout entire development teams or manufacturing groups.

The File Viewer uses the same N77xx Windows-based graphical user interface that is used in the measurement engine packages. The controls for this interface can also be built into customized programs for automated data display.

For performing measurement tasks, an increasing range of application packages are available. Some basic ones are available free for use with the instruments. Licenses can be purchased for more advanced packages. All packages can be downloaded and used immediately for a 14 day trial period and 60-day evaluation licenses can also be generated automatically from the Keysight web site for extended consideration.

Insertion loss

The Insertion Loss measurement package performs very accurate swept-wavelength insertion loss measurements using one of Keysight's tunable laser sources along with optical power meters. No license required.

Fast IL/PDL measurement

The Fast IL/PDL measurement package makes rapid and very accurate measurements of spectral insertion loss and polarization dependent loss (PDL) characteristics of multiport optical components. The new single sweep Mueller Matrix method provides speed and immunity from vibrations and noise. Measurements including multiple lasers for wider wavelength coverage and return loss module are now also supported.

In addition to the measured IL and PDL traces, the Mueller Matrix data can be exported and analyzed to provide the polarization resolved IL traces for the device axes (TE/TM). Measurement of optical-to-electrical devices like receiver assemblies is also supported as described on page 6.

The matrix analysis for calculating the IL traces aligned with TE or TM is especially valuable for fast characterization on wafers or chips (integrated photonics), often eliminating the need to directly align and stabilize the polarization launched into the device. License available for purchase as **N7700A-100**.

Filter analysis

The Filter Analysis package provides extended post-processing of measurements from the IL/PDL and IL measurement packages for analysis of narrow-band components like filters and multiplexers. Analysis parameters include peak and center wavelength, wavelength offset from ITU grid, IL at ITU wavelength and center wavelength, bandwidth and channel isolation from adjacent and non-adjacent channels. From the TE & TM traces of the IL/PDL engine, the polarization dependent frequency shift (PDF or PDL) of channels in filters, interleavers or phase demodulators can also be determined. A convenient peak search function is also included. License available for purchase as **N7700A-101**.

Fast spectral loss measurement

This package measures insertion loss and power spectra at enhanced repetition rate and is a valuable tool for tuning and calibrating devices with near real-time feedback. Especially powerful in combination with the 81606A and 81960A tunable laser using bidirectional sweeps, repetition rates of 1 to 3 scans per second can be attained, depending on the sweep range. This package also provides stitching of scans with multiple power ranges for highest dynamic range. License available for purchase as **N7700A-102**.

Polarization Navigator

The Polarization Navigator package provides all the tools needed for your work with N778x polarization analysis and control instruments: measurement of Stokes parameters and degree of polarization (DOP); representation on the Poincaré sphere or time dependent long term monitoring, spike analysis, etc. Various functions for control, switching and scrambling the polarization of optical signals are also provided. No license required for use with N778x instruments.

81600B, 81602A, 81606A, 81607A, 81608A, 81609A Tunable Laser Modules

www.keysight.com/find/tls

- Complete wavelength coverage from 1240 to 1650 nm
- High power with low SSE for high dynamic range
- Fast two-way sweeps to reduce test times
- Built-in wavelength meter for optimum tuning precision
- Specified performance in the continuous sweep mode



Single-Box Test solution for swept wavelength characterization

Keysight 8160xx Family of Tunable Laser Sources

The Keysight 8160xx tunable laser modules fit into the bottom slot of the Keysight 8164B Lightwave Measurement System mainframe.

The Keysight 81606A Top-Line Tunable Laser Source

The new 81606A Option 216 Tunable Laser Source is the new flagship model, featuring the widest tuning range of 200 nm, and an outstanding dynamic wavelength accuracy and repeatability. The excellent low-SSE performance of better than 80 dB/nm signal-to-source spontaneous emission ratio (signal-to-SSE ratio) and the high signal power permit measurements of wavelength isolation to 100 dB, most often limited by power meter sensitivity.

The Keysight 81607A, 81608A Value Line Tunable Laser

The new 81607A value line tunable laser source complements the top line 81606A model at a moderately reduced output power. With a typical wavelength repeatability of ± 1 pm even during two-way sweeps with up to 200 nm/s, it is ideal for high-throughput test and automated adjustment of passive optical components. The new 81608A, another member of the value line tunable laser sources, offers a peak output power of more than +12 dBm, at least 75 dB/nm above its spontaneous emission level. The 81608A features a typical wavelength repeatability of ± 1.5 pm at two-way sweeps up to 200 nm/s. The laser's balance of features, performance and price makes it suitable for both coherent transmission experiments and cost-effective manufacturing-floor component testing.

The Keysight 81609A Basic Line Step-Tunable Laser

The new 81609A basic line module can step within 300 milliseconds to discrete wavelengths with a resolution of 0.1 pm and a typical wavelength repeatability of ± 3 pm, making it ideal for cost-effective testing of broadband optical devices. Like the other modules in the family, it delivers more than +12 dBm peak output power with low spontaneous emission levels. At ± 0.01 dB power stability over an hour, it can also serve as a static local oscillator with a wide tuning range for receiver testing or transmission experiments.

Improved O-band models for Silicon Photonics applications

The new 8160xA option 113 covers the wavelength range from 1240 nm to 1380 nm for an important set of applications. Equipped with PMF output fiber, these are a good match for testing and developing components with Silicon Photonics technology. Verifying the spectral responsivity and the sensitivity of receiver optical subassemblies (ROSA) for 100G Ethernet benefit from more than +10 dBm output power - enough to allow for external modulation in BER testing. Combined with very low SSE levels, Option 113 is ideal for testing wavelength filters for LR4 components.

The Keysight 81602A: An O-band Tunable Laser Source Exceeding 63 mW Output Power

The new 81602A Tunable Laser Source reaches an optical power level of over +18 dBm. The high output power helps compensate for the coupling loss of optical surface probes or the insertion loss of external modulators during the verification of integrated photonic designs. This allows testing photonic devices at relevant signal levels and wavelengths. With a tuning range of 1250 nm to 1370 nm, the laser addresses the latest Silicon Photonics research.

The extra high power tunable laser model extends power budget limits in test setups and speeds fiber or probe alignment by getting first light faster: +18 dBm output power help overcome the limitations of probe coupling efficiency, particularly where surface probes need to operate over a broad wavelength range.

Characterize filters

A critical aspect of measuring filters to demultiplex wavelengths is the spectral isolation which determines the crosstalk between signals at different wavelengths. The insertion loss should be low for desired wavelengths and high for wavelengths that should be rejected and routed elsewhere.

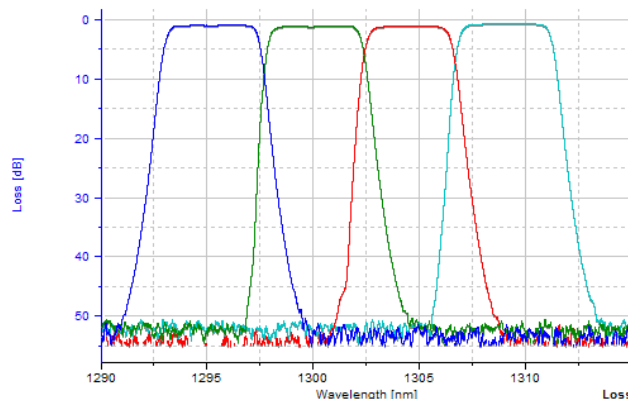

www.keysight.com/find/tls

An aspect of lasers that cover wide wavelength ranges is the broadband spectrum of the optical emitter medium. In a laser cavity, most of the emitted power is stimulated at the tuned wavelength, but a natural proportion of broadband source spontaneous emission (SSE) is also produced. Since some of this light will be in the passband wavelengths of a filter, even when the laser line is blocked, a power meter will receive some background light after the filter. This effect is stronger when the passband is wider, like for CWDM filters. This limits the dynamic range for measuring the isolation.

Low-SSE optical output port

The 81606A features a single optical output with more than +12 dBm output power. It combines the highest power level with the lowest SSE level in the 8160xx product family, 80 dB/nm below the signal. The 81607A comes with +8 dBm peak output power, 81608A and 81609A with more than +12 dBm, 75 dB/nm above their spontaneous emission level. For all 8160xA modules, the output power can be reduced to 0 dBm by the user.

Realize the cost efficiency and performance benefits in WDM component tests

The testing of optical filters is based on a generic principle, namely the stimulus-response test. The state-of-the-art approach is a wavelength-resolved stimulus-response measurement utilizing a tunable laser source that is capable of fast and precise sweeps across the entire wavelength range, and optical power meters.

For DWDM components, high wavelength accuracy and dynamic range are critical. For CWDM and PON components, a wide wavelength range, dynamic range and tight costing are key targets. If the investment in the test solution can be shared among many different types of filters, the contribution to each individual filter is minimized. In this way, cost targets for CWDM and PON components can be met without sacrificing accuracy. Investing in the Keysight 8160xx Family of Tunable Laser Sources can realize both the cost efficiency and performance benefits required.

Keysight tunable laser module selection table

	1240 nm	1360 nm	1460 nm	1530 nm	1565 nm	1625 nm	1675 nm	
	O-Band	E-Band	S-Band	C-Band	L-Band	U-Band		
Compact, JET, iTLA-based				81950A-310 N771xA-340	81950A-301 N771xA-304			
Compact, ECL-based					81949A			
Swept-wavelength measurements			81989A		81940A			
					81960A-E62			
			81980A					
Full-size, ECL-based			81606A-216, , 81608A-216 (200 nm)					
	81602A-013		81606A/7A/8A -116 (150 nm)					
		81600B-140, 81600B-142						
	81606A-113, 81608A-113							

www.keysight.com/find/tls

- Modular design for multichannel platform
- Up to 125 nm coverage in one module
- Better than 2 Hz repetition rate in fast swept mode
- Device characterization at high power levels up to +14 dBm
- SBS suppression feature enables high launch power
- Excellent power and wavelength repeatability



High power compact tunable lasers for S-, C- and L-band

The Keysight 819xxA Series of compact tunable laser sources enables optical device characterization at high power levels and measurement of nonlinear effects. Each of the 819xxA lasers enhances the testing of systems, all types of optical amplifiers and other active components, as well as passive optical components.

As single-slot plug-in modules for the Keysight Technologies 8163A/B, 8164A/B, and 8166A/B mainframes, Keysight's compact tunable laser sources are a flexible and cost effective stimulus for single channel and DWDM test applications.

Keysight's 8198xA, 81960A and 8194xA compact tunable laser sources provide high output power up to +13 dBm.

The 81980A and 81989A modules cover a 110 nm wavelength range in the S- and C-band, the 81940A and 81949A modules operate over 110 nm in the C- and L-band, and the 81960A scans even 125 nm including the C- and L-band.

Fast swept spectral loss measurement

The Keysight 81960A sets a new mark in tunable laser performance with faster sweep speeds and repetition rates combined with the dynamic accuracy specifications needed for DWDM component measurements.

Dynamically specified sweeps in both directions enhance the repetition rate even further for real-time use in adjustment and calibration procedures. Rocket-fast and accurate, the 81960A helps you hit your development and production targets.

An ideal stimulus for DWDM system loading

The Keysight Technologies 81950A system-loading source is step-tunable for setting channel frequencies within the C- or L-band. With high output power up to +15 dBm, narrow linewidth of 100 kHz, gridless and grid-defined wavelength setting, and offset fine-tuning capability, the 81950A is a universal source for realistic loading of the latest transmission systems.

Continuous sweep mode with wavelength logging

The 81940A, 81960A and 81980A can be operated in the continuous sweep mode with dynamic wavelength logging to make measurements during the wavelength sweep. This functionality forms the basis for fast wavelength-dependent measurements of passive and detecting optical components. Spectral measurements with tunable lasers provide high dynamic range and highest wavelength resolution.

Built-in wavelength meter for active wavelength control

The 81940A, 81960A and 81980A feature a built-in wavelength meter with a closed feedback loop for enhanced wavelength accuracy. In continuous sweep mode, the meter allows dynamic wavelength logging to make accurate measurements during the sweep.

Dynamic power control for excellent reproducibility

The integrated dynamic power control loop ensures a high reproducibility in power level. Highly repeatable measurements reduce errors when comparing the results of several wavelength sweeps. As the 81940A, 81960A and 81980A feature mode-hop-free tunability over their entire tuning range with continuous output power, they achieve highly accurate measurements over wavelength.

Coherence control avoids interference-induced power fluctuations

In 8194xA, 81960A and 8198xA modules, a high-frequency modulation function is used to increase the effective linewidth to avoid power fluctuations due to coherent interference effects. The modulation pattern is optimized for stable power measurements, even in the presence of reflections.

www.keysight.com/find/tls



Compact tunable laser source with dual power meter in one box

Accurate DWDM component measurements at full scan rate

The 81960A module adds the new and unique capability to sweep in both directions, and sports increased sweep speeds and acceleration. Its dramatically improved and fully specified dynamic accuracy enables DWDM component measurements and adjustments at high repetition rate, and boosts the characterization of single and multichannel components. The laser is especially well supported by the swept-wavelength measurement engines in the N7700A software suite and can be programmed directly.

The most specially adapted application for this laser is high repetition-rate scanning for real-time updates, enabled by the Keysight N7700A-102 fast-sweep insertion loss engine. It synchronizes the laser with the N7744A or N7745A power meters to produce power and loss spectra in a convenient GUI display, and accelerates the uploading of the logged wavelength monitor data.

The wavelength resolution and 50 to 60 dB dynamic range achieved surpass comparable measurements by an Optical Spectrum Analyzer (OSA), with repetition rates better than 2 Hz for add-drop filter adjustment and calibration.

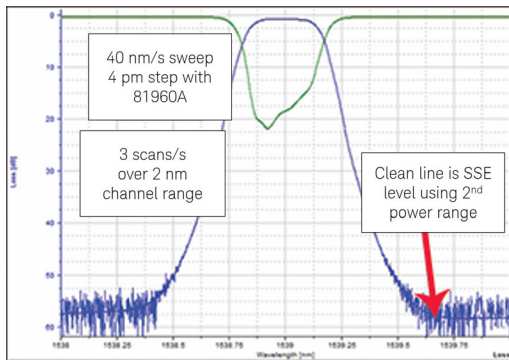

Dynamic range is > 55 dB with 25 μ s averaging time, sufficient to perform a 55 dB isolation test of a 50 GHz filter at 40 nm/s.

The high performance in continuous sweeps also matches this laser well to the single-sweep PDL and IL N7700A-100 measurement engine. The enhanced dynamic wavelength accuracy will satisfy the test needs for many DWDM components at an optimized performance/price balance. The source to spontaneous noise ratio, SSE, while not as high as the 81600B series, is also sufficient to qualify the isolation of many filter devices. The higher sweep speeds save time measuring broadband devices not needing such high wavelength resolution.

These same advantages apply to use with the N7788B component analyzer for measuring PMD and DGD in addition to PDL and IL. The relative wavelength accuracy during the sweeps is especially important for accurate DGD measurements using the JME method, since the result depends on the derivatives with respect to wavelength. The high speed is great for measuring isolators, PMF and other broadband components.

The powerful lambda scan functions of the 816x Plug&Play driver for customized programs, and the N7700A IL engine which provides a GUI interface to these functions also support power and IL measurements together with any of the Keysight power meters. And the performance of swept-wavelength measurements in the N4150A PFL, including fast repetitive sweeps are also supported with this newest member of the Keysight swept tunable lasers.

Device characterization at high power levels

The high optical output power of the 819xxA tunable lasers enhances test stations for optical amplifier, active components and broadband passive optical components. It helps overcome losses in test setups or in the device under test itself. Thus, engineers can test optical amplifiers such as EDFAs, Raman amplifiers, SOAs and EDWAs to their limits. These tunable lasers provide the high power required to speed the development of innovative devices by enabling the test and measurement of nonlinear effects.

Internal modulation

The internal modulation feature of 81940A, 81960A, 81980A, 81949A and 81989A enables an efficient and simple time-domain extinction (TDE) method for Erbium-based optical amplifier test. It also supports the transient testing of optical amplifiers by simulating channel add and drop events.

SBS Suppression feature enables high launch power

The SBS-suppression feature prevents the reflection of light induced by Stimulated Brillouin Scattering (SBS). It enables the launch of the high power into long fibers without intensity modulation.

	81980A, 81940A	81960A Option E62	81950A Tunable System Source
Wavelength range	1465 to 1575 nm (81980A) 1520 to 1630 nm (81940A)	1505 to 1630 nm	1527.60 to 1570.01 nm (196.25 to 190.95 THz, 81950A-310) 1570.01 to 1611.76 nm (190.95 to 186.00 THz, 81950A-301)
Wavelength resolution	1 pm, 125 MHz at 1550 nm	0.1 pm, 12.5 MHz at 1550 nm	Typ. 100 MHz, 0.8 pm at 1550 nm
Mode-hop free tuning range	Full wavelength range	Full wavelength range	
Maximum tuning speed	50 nm/s	200 nm/s	< 30 s (incl. power stabilization)
Fine tuning range / resolution			typ. ± 6 GHz / typ. 1 MHz
Absolute wavelength accuracy ¹	± 20 pm, typ. ± 5 pm	± 10 pm, typ. ± 5 pm	± 22 pm (± 2.5 GHz)
Relative wavelength accuracy	± 10 pm, typ. ± 5 pm	± 7 pm, typ. ± 3 pm	± 12 pm (± 1.5 GHz)
Wavelength repeatability	± 2.5 pm, typ. ± 1 pm	± 2.5 pm, typ. ± 1.5 pm	Typ. ± 2.5 pm (± 0.3 GHz) ³
Wavelength stability (typ.) ³	$\leq \pm 25$ pm over 24 hours	$\leq \pm 0.5$ pm over 1 min	$\leq \pm 2.5$ pm (± 0.3 GHz) over 24 hours $\leq \pm 2.5$ pm over 15 min
Linewidth, coherence control off	Typ. 100 kHz	Typ. 100 kHz	Typ. 100 kHz, SBS suppression off
Effective linewidth (typ., coherence control on) ²	> 50 MHz (1525 to 1575 nm, 81980A) > 50 MHz (1570 to 1620 nm, 81940A)	> 50 MHz (at max. constant output power)	
Maximum output power (continuous power during tuning)	> +14.5 dBm peak $\geq +13$ dBm (1525 to 1575 nm, 81980A) $\geq +13$ dBm (1570 to 1620 nm, 81940A) $\geq +10$ dBm (1465 to 1575 nm, 81980A) $\geq +10$ dBm (1520 to 1630 nm, 81940A)	$\geq +14$ dBm peak, typ. $\geq +13$ dBm (1570 to 1620 nm)	$\geq +13.5$ dBm (typ. $\geq +15$ dBm) Option 310 $\geq +11.5$ dBm (typical $\geq +13$ dBm) Option 301
Power range (nominal)	+6 dBm to maximum output power	+6 dBm to maximum output power	8 dB off maximum output power
Power linearity	Typ. ± 0.1 dB	± 0.15 dB (1505 nm, 1575 nm, 1630 nm)	
Power stability ³	± 0.01 dB over 1 hour Typ. ± 0.03 dB over 24 hours	± 0.01 dB over 1 hour Typ. ± 0.03 dB over 24 hours	Typ. ± 0.03 dB over 24 hours
Power flatness versus wavelength	± 0.3 dB, typ. ± 0.15 dB	± 0.2 dB (1570 nm to 1620 nm, +13 dBm) ± 0.3 dB (full wavelength range)	Typ. ± 0.2 dB (full range)
Power repeatability (typ.)	± 0.01 dB	± 0.01 dB	± 0.08 dB ³
Power repeatability (typ.)	≥ 50 dB	≥ 50 dB	50 dB
Signal to source spontaneous emission ratio ⁴	≥ 45 dB/nm ² 48 dB/nm (1525 to 1575 nm, 81980A) ² 48 dB/nm (1570 to 1620 nm, 81940A) ²	≥ 45 dB/nm (+10 dBm) ≥ 50 dB/nm (1525 to 1620 nm, +12 dBm)	Typ. 50 dB/1 nm ²
Signal to total source spontaneous emission ratio (typ.) ²	≥ 25 dB ≥ 30 dB (1525 to 1575 nm, 81980A) ≥ 30 dB (1570 to 1620 nm, 81940A)	≥ 25 dB (+10 dBm) ≥ 30 dB (1525 to 1620 nm, +12 dBm)	
Relative intensity noise (RIN) (typ.) ²	-145 dB/Hz	-145 dB/Hz (0.1 GHz to 6 GHz)	-145 dB/Hz (10 MHz to 40 GHz)
Dimensions (H x W x D)	75 mm x 32 mm x 335 mm	75 mm x 32 mm x 335 mm	75 mm x 32 mm x 335 mm

1. At day of calibration.
2. At maximum output power as specified per wavelength range.
3. At constant temperature ± 0.5 K.
4. Value for 1 nm resolution bandwidth.
5. For sweep range 1510 to 1625 nm. For 200 nm/s, sweep range is 1528 to 1608 nm.
6. Repeatability within the same direction. At 200 nm/s, the specification value is double for sweeps from long to short wavelength.

Ordering information

81960A-E62	Fast-Swept Compact Tunable Laser, 1505 to 1630 nm, step and fast sweep mode
81940A	Compact Tunable Laser Source L-band, 1520 to 1630 nm, step and sweep mode
81980A	Compact Tunable Laser Source C-band, 1465 to 1575 nm, step and sweep mode
81950A-310	Tunable System Source C-band, step mode
81950A-301	Tunable System Source L-band, step mode

1. All tunable lasers must be ordered with one connector option.
2. # 071 for PMF, straight output (not available for 81960A).
3. # 072 for PMF, angled output.
4. One Keysight 81000xl-series connector interface is required.

www.keysight.com/find/tls

N7711A, N7714A Tunable laser sources

- Compact instrument format with one or four ports per unit on one-half rack-unit width and one-unit height
- Flexible configuration of four-port model between C- and L-band channels (N7714A)
- Adjustable to any wavelength grid (ITU-T 100 GHz, 50 GHz, 25 GHz, and arbitrary grids), or use gridless wavelength setting
- Narrow linewidth less than 100 kHz and offset-grid tuning greater than ± 6 GHz ideally suited for coherent mixing applications and new complex modulation formats
- Up to +15 dBm output power, with 8 dB power adjustment range
- Polarization maintaining fiber output

The new Keysight N7711A and N7714A tunable lasers are single-port and four-port sources, available with C-band or L-band wavelength coverage. The narrow linewidth and offset grid fine-tuning capability of the N7711A and N7714A make them ideal sources for realistic loading of the latest transmission systems.



N7711A one-port Tunable Laser Source



N7714A four-port Tunable Laser Source

The N7711A and N7714A tunable laser sources are step-tunable within any frequency grid in the C-band (1527.60 to 1570.01 nm; 196.25 to 190.95 THz) or L-band (1570.01 to 1611.76 nm; 190.95 to 186.00 THz). Their output power of up to +15 dBm and a linewidth under 100 kHz are ideal to emulate state-of-the-art DWDM transmitters. SBS suppression can be activated on demand to avoid stimulated Brillouin scattering.

Tuning modes that fit every application

Each individual laser in the N7711A and N7714A features the same tuning modes as the 81950A: in channel setting mode, the source wavelength, (or frequency, respectively) is determined by the chosen channel index, zero frequency and grid spacing; ITU-T standard grids are possible as well as custom grids. In wavelength setting mode the laser operates gridless and is tunable to any wavelength point within its range, just like any other Keysight tunable lasers. In both modes, each laser channel operates independently and can be fine-tuned by ± 6 GHz with output power active.

The 77-Viewer: An easy-to-use graphical user interface

The 77's Window's based graphical user interface offers flexible and extensive control of the instrument.

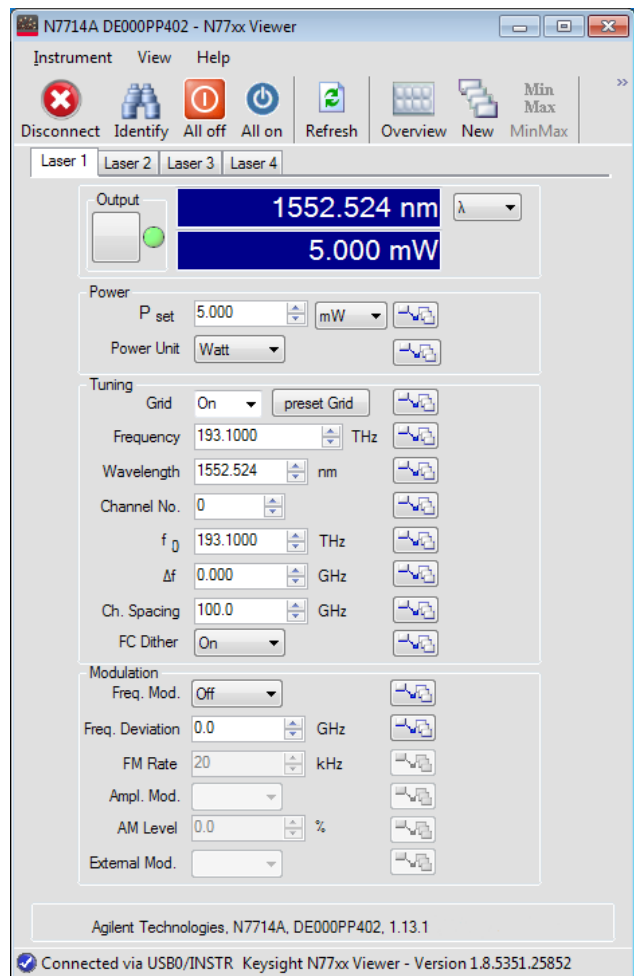

N7711A and N7714A Tunable Laser Source

www.keysight.com/find/tls

Technical Specifications N7711A and N7714A (Specifications apply to wavelengths on the 50 GHz ITU-T grid, after warm up.)		
Wavelength	Options #310, #322, #340	Options #301, #322, #304
Wavelength range	1527.60 nm to 1570.01 nm (196.25 THz to 190.95 THz)	1570.01 nm to 1611.76 nm (190.95 THz to 186.00 THz)
Fine tuning range	Typ. ± 6 GHz	
Fine tuning resolution	Typ. 1 MHz	
Absolute wavelength accuracy	± 22 pm (± 2.5 GHz)	
Relative wavelength accuracy	± 12 pm (± 1.5 GHz)	
Wavelength repeatability	Typ. ± 2.5 pm (± 0.3 GHz)	
Wavelength stability	Typ. ± 2.5 pm (± 0.3 GHz), 24 hours	
Tuning time including power stabilization	Typ. < 30 s	
Optical power		
Maximum output power	$\geq +13.5$ dBm Typ. $\geq +15$ dBm	$\geq +11.5$ dBm Typical $\geq +13$ dBm
Power stability	Typ. ± 0.03 dB over 24 hours	
Power flatness	Typ. ± 0.2 dB (full wavelength range)	
Power repeatability	typ. ± 0.08 dB	
Spectral		
Linewidth	Typ. < 100 kHz (SBS suppression off)	
Side mode suppression ratio (SMSR)	Typ. 50 dB	
Source spontaneous emission (SSE)	Typ. 50 dB/ 1 nm Typ. 60 dB/ 0.1 nm	
Relative intensity noise (RIN)	Typ. -145 dB/Hz (10 MHz to 40 GHz)	

Non-warranted Performance Characteristics N7711A and N7714A

Grid spacing	100, 50, 25 GHz, arbitrary grid, or gridless
Output power	
Power attenuation range	8 dB
Power setting resolution	0.1 dB
Residual output power (shutter closed)	≤ -45 dBm
Stimulated brillouin scattering	
SBS suppression FM p-p modulation range	0 to 1 GHz
SBS suppression dither frequency	20.8 kHz

www.keysight.com/find/oct

The Keysight 81663A high power DFB laser source modules are best suited for multiple fixed-wavelength test applications, like PON component test.

- Center wavelengths: 1310 nm, 1490 nm, 1510 nm, 1550 nm, 1625 nm
- Fine tuning capability ± 500 pm
- Excellent power and wavelengths stability
- Up to 20 mW output power



The Keysight 81663A modules offer +13 dBm output power to overcome power penalties given in today's test setups. Their excellent power and wavelength stability is key for accurate testing of IL and PDL at PON wavelengths.

Applications

- PON component IL & PDL test
- PON Stimulus-response measurement

Keysight 81663A Option	#131	#149	#151	#155	#162
Specifications apply to maximum power setting					

Type	CW DFB laser with built-in isolator				
Center wavelength ^{1,2}	1310 nm ± 5 nm	1490 nm ± 3 nm	1510 nm ± 3 nm	1550 nm ± 3 nm	1625 nm ± 3 nm
Tuning range	Typ. $> \pm 500$ pm				
- Display resolution	10 pm				
- Repeatability ³	± 5 pm (typ. ± 2 pm)				
- Stability (15 min.) ^{3,4}	± 5 pm (typ. ± 2 pm)				
- Stability (24 h) ^{3,4}	Typ. ± 5 pm				
Fiber type	Panda PMF 9 / 125 mm				
Output connector ⁶	Compatible to angled contact APC, ASC, DIN47256/4108				
Power					
- Max. output ⁵	Typ. $> +13$ dBm (20 mW)				
- CW stability (15 min) ⁴	Typ. ± 0.003 dB				
- CW stability (24 h) ^{3,4}	Typ. ± 0.01 dB				
Side mode suppression ratio (SMSR) ⁵	Typ. 50 dB				
Polarization extinction ratio (PER)	Typ. > 20 dB				
Dimensions (H x W x D)	75 mm x 32 mm x 335 mm (2.8" x 1.3" x 13.2")				
Weight	0.5 kg				
Recalibration period	2 year				
Operating temperature	15 to 35 °C				
Warm-up time ³	60 min				

- Center wavelength is shown on display as default.
- Via GPIB tuning resolution < 10 pm.
- If previously stored at the same temperature 20 min.
- Controlled environment $DT = \pm 1$ °C.
- At maximum power setting and default wavelength at the end of a 2m SM patchcord.
- Connector interface not included.

8165xA Fabry-Perot Laser Modules

www.keysight.com/find/oct

- SMF with 1310, 1550 or 1310/1550 nm and MMF with 850 nm
- 20 mW output power
- Excellent CW power stability of $< \pm 0.005$ dB (15 min.)
- Stable test of patchcords, couplers and connectors



The Keysight Fabry-Perot laser sources are available as single or dual wavelength sources, are insensitive to back reflections, and are stabilize for short and long term applications.

Flexible application fit

Keysight 8165xA Fabry-Perot laser sources are a family of plug-in modules for Keysight's lightwave solution platform and offer ideal power and loss characterization of optical components and fibers with wavelengths at 850 nm, 1310 nm and 1550 nm, mainly used in optical telecommunication including today's fiber to the home (FTTH) and short reach applications such as Fibre Channel and Gigabit Ethernet.

Ideal solution for IL, RL and PDL tests

Combination of Keysight's Fabry-Perot laser source and wide variety of power meters (or optical heads) provides the basic setup for insertion loss (IL) characterization. Simple front panel operation together with a power meter immediately show results of IL. Keysight's 8161xA return loss module can utilize an external laser source such as a Fabry-Perot laser to set up a return loss (RL) test. Adding the Keysight 8169A or N7785B polarization controller enables testing of the polarization properties of optical components.

850 nm source

For 850 nm, the special 81655A Option E03 is also offered with 50/125 μ m multimode output.

High power modules, +13 dBm	Keysight 81655A	Keysight 81656A	Keysight 81657A
Type		Fabry-Perot laser	
Center wavelength ¹	1310 nm \pm 15 nm	1550 nm \pm 15 nm	1310/1550 nm \pm 15 nm
Fiber type		Single-mode 9/125 μ m	
Spectral bandwidth (rms) ^{1,2}	< 5.5 nm (high power)	< 7.5 nm (high power)	< 5.5 nm/ 7.5 nm (high power)
Output power		$> +13$ dBm (20 mW) (high power)	
CW power stability ^{3,4}		$< \pm 0.005$ dB	
Short term (15 min.)		Typ. $< \pm 0.003$ dB with coherence control active	
Long term (24 h)		typ. ± 0.03 dB	
To back reflection (RL ³ 14 dB)		typ ± 0.003 dB	
Dimensions (H x W x D)		75 mm x 32 mm x 335 mm (2.8" x 1.3" x 13.2")	
Weight		0.5 kg	
Recalibration period		2 years	
Operating temperature		0 °C to 45 °C	
Humidity		Non condensing	
Warm-up time		60 minutes ³	

1. Central wavelength is shown on display.

2. rms: root mean square.

3. Warm-up time 20 min, if previously stored at the same temperature.

4. Controlled environment ($T = \pm 1$ °C).

www.keysight.com/find/mppm

- Patented 4-port optical connector interface for FC, SC, LC, MU and bare-fiber
- Storage of up to 1 million power values per channel for high speed measurement data acquisition and transfer
- Short minimum averaging time of 1 μ s for high time resolution and transient power measurements
- LAN, USB and GPIB programming interfaces
- High dynamic range with high bandwidth for accurate high-speed spectra
- Code compatibility to Keysight's Lightwave Measurement System platform



Keysight N7745A Multiport Power Meter with Quad-Adapter Connector Interfaces N7740ZI, N7740FI, N7740BI, N7740KI (left to right)

Up to eight power meter channels in a small package

Keysight's new N7744A and N7745A optical power meters with four or eight power-sensor channels provide manufacturing customers with increased throughput and operational efficiency to meet today's challenges in manufacturing.

Designed for optical multiport applications

Designed for characterizing optical multiport components, these optical power meters offer industry-leading solutions for device connectivity, high-speed measurement data acquisition and fast data transfer for postprocessing. The multiport power meter enables fast measurement solutions for all multiport devices; for example multiplexers, PON splitters, wavelength selective switches (WSS) and ROADMs, as well as compact setups for simultaneous testing of multiple single-port devices. These power meters are easily integrated with a tunable laser using the N7700A software to make fast IL and PDL measurements.

Continuous data logging

Each channel can log up to 1 M samples and has an additional 1 M buffer. Sampling can be set between 1 μ s and 10 s. The buffer allows data upload during measurements for uninterrupted transient power measurement and monitoring.

A reliable four-port optical connection with a new one-click quad-adapter

With this new power meter comes the unprecedented N7740xl fiber connectivity concept, which is a quadruple adapter with a snap-on quick-locking mechanism. The device to be tested can be connected to the quad-adapters in a comfortable ergonomic working position, even while the instrument is measuring another device. Then the quad-adapters can quickly be snapped on, to provide repeatable high-precision connections. Use of the quad-adapters simplifies aligning connector keys, especially for rack-mounted instruments and makes it easier to connect ports in the desired order, helping to avoid errors and connector damage. This quad-adapter fits also into Keysight's standard bare fiber connectivity solutions 81000Bx.

Keysight N7744A, N7745A

Sensor element	InGaAs
Wavelength range	1250 to 1650 nm
Specification wavelength range	1250 to 1625 nm (if not stated differently)
Power range	- 80 to +10 dBm
Maximum safe power	+16 dBm
Data logging capability	1 million measurement points per port
Averaging time	1 μ s to 10 s
Applicable fiber type	Standard SM and MM \leq 62.5 μ m core size, NA \leq 0.24
Uncertainty at reference conditions	\pm 2.5%
Total uncertainty	\pm 4.5%
Relative port to port uncertainty	typ. \pm 0.05 dB
Linearity at (23 \pm 5°C) over operating temperature	\pm 0.02 dB \pm 3 pW \pm 0.04 dB \pm 5 pW
Polarization dependent responsivity	< \pm 0.015 dB (1520 to 1580 nm) Typ. < \pm 0.01 dB (1250 to 1580 nm)
Noise peak-to-peak (dark)	< 7 pW (1 s averaging time, 300 s observation time)
Return loss	> 50 dB (1520 to 1580 nm) typ. > 57 dB (1280 to 1580 nm)
Operating temperature	+5 to +40 °C
Operating humidity	15% to 95%, non-condensing
Storage conditions	-40 °C to +70 °C
Warm-up time	20 min.
Dimensions (H x W x D)	372 mm \times 212 mm \times 43 mm
Weight	3 kg (6 lb)

N7747A and N7748A High Sensitivity Optical Power Meter

www.keysight.com/find/jet

With the N7747A and N7748A, the highest optical performance is now offered in the N77 platform for compact automated instrumentation. The high optical performance encompasses the highest sensitivity available with -110 dBm and correspondingly low noise and high stability to accurately measure and monitor weak signals and small signal changes. This is supported by high relative power accuracy with low polarization dependence and low spectral ripple. The high sensitivity together with 9 power ranges at 10 dB spacing provides highest dynamic range with excellent linearity.

These instruments combine the proven optical performance of the 81634B sensor modules with the large memory, fast data transfer and small footprint of the N77 series platform. Eight high-sensitivity optical power meters now fit in a single rack unit. Optical connections are made with the interchangeable 81000xl connector interface system so the instrument can be easily adapted to different fiber connector types. Each optical port has 2 buffers of memory, each able to log up to 1 M samples. With the ability to upload one buffer while the other is recording measurements, this permits continuous monitoring over extended times with sensitivity to small transients. Details for programming this logging are given in the application note 5990-3710. The functionality is the same used in the N7744A and N7745A except that the high-sensitivity models use lower bandwidth to match the low-noise performance.

Like the 81634B and the 8162*B optical power heads, the N7747A and N7748A include an analog output for each optical channel. This provides a 0 to 2 V signal proportional to the optical power, scaled by the selected power range and allows analog monitoring of signals with up to 5 kHz bandwidth.

The instruments have USB, LAN and GPIB interfaces for control with the SCPI command set also used for the 816x, N7744A and N7745A optical power meters. The updated versions of the N77xx Viewer user interface program and the 816x VXI Plug&Play driver can also be used.



	N7747A and N7748A	-110 dBm
Sensor element	InGaAs	
Wavelength range	800 to 1700 nm	
Power range	-110 to $+10$ dBm	
Maximum safe input power	$+16$ dBm	
Applicable fiber type	Standard SM and MM, ≤ 100 μm core size, $\text{NA} \leq 0.3$	
Uncertainty at reference conditions ¹	$\pm 2.5\%$	
Total uncertainty ^{2,3}	$\pm 4.5\%$	
Polarization dependent responsivity ⁴	$< \pm 0.005$ dB	
Spectral ripple (due to interference) ⁵	$< \pm 0.005$ dB	
Linearity ^{3,6}	$< \pm 0.015$ dB (at $23^\circ \pm 5^\circ\text{C}$) $< \pm 0.05$ dB (in operating temperature range) $< \pm 0.005$ dB (fixed power range, within 10 dB of range max.)	
Noise (peak to peak, dark) ⁷	< 0.2 pW (1200 to 1630 nm)	
Drift		
Return loss	> 55 dB	
Analog output	0 to 2 V in to open, 600 ohm typ. output impedance, max input voltage ± 10 V	
Frequency response (3 dB cutoff, also for analog output)	5.0 kHz ($+10$ dBm to -20 dBm range) 4.0 kHz (-30 dBm to -40 dBm range) 0.3 kHz (-40 dBm to -70 dBm range)	
Averaging time	10 μs to 10 s	
Data logging capability	2 buffers/port, each with 1 Mio. measurement point capacity	

1. Reference conditions: Power level 10 μW (-20 dBm), continuous wave, Fiber 50 μm graded-index, $\text{NA} = 0.2$, Ambient temperature $23^\circ\text{C} \pm 5^\circ\text{C}$, On day of calibration (add $\pm 0.3\%$ for aging over 1 year, add $\pm 0.6\%$ over 2 years), Spectral width of source < 10 nm (FWHM), Wavelength setting at power sensor must correspond to source wavelength ± 0.4 nm.

2. Operating conditions: Fiber ≤ 50 μm , $\text{NA} \leq 0.2$, connectors with 2.5 mm ferrule with flat face (fiber tip offset not more than 0.3 mm from 2.5 mm cross-section) with straight or angled polish, within one year after calibration, add 0.3% for second year, operating temperature range as specified humidity: none condensing.

3. Excluding noise and drift.

4. All states of polarization at constant wavelength (1550 ± 30 nm) and constant power, straight connector, $T = 23^\circ\text{C} \pm 5^\circ\text{C}$. For angled connector (8°) add ± 0.01 dB typ.

5. Test conditions: wavelength 1550 ± 30 nm, fixed state of polarization, constant power, temperature $23^\circ\text{C} \pm 5^\circ\text{C}$, linewidth of source ≥ 100 MHz, angled connector 8° .

6. CW, -90 to $+10$ dBm, 1000 to 1630 nm.

7. Averaging time 1 s, $T = 23^\circ\text{C} \pm 5^\circ\text{C}$, $\Delta T \pm 1^\circ\text{C}$, observation time 300 s.

www.keysight.com/find/oct

- Complete wavelength range, 450 to 1800 nm
- Low uncertainty of $\leq \pm 0.8\%$ at reference conditions
- Low PDL of $\leq \pm 0.005$ dB, for polarization sensitive tests
- High single-sweep dynamic range of 55 dB
- High power measurements of up to +40 dBm
- Support of high channel count testing with dual power sensor
- Support of bare-fiber and open-beam applications with a 5 mm detector
- Synchronous measurements with a laser source or external modulation



Wide variety of optical power sensors and optical heads

The superiority of Keysight's stimulus-response test solutions guarantee performance. Keysight has been an industry leader in optical instrumentation since the early 1980s - excellence in laser sources, reliable power sensor modules and large detector optical heads.

The power measurement instruments are available in two formats: self-contained power sensor modules for front-panel optical fiber connection and external power measurement heads for flexible connection positioning, which are connected to the mainframe using the 81618A or 81619A (dual) interface modules. The external beams with a large 5 mm detector are also useful in many free-space optical configurations.

The flexible connector interface system allows the same instrument to be used with many different types of optical connector.



81628B InGaAs head with integrating sphere

Passive component test

For multi-channel devices, such as CWDM and AWG, for R&D or the manufacturing environment, accurate measurements at a minimum cost are in demand. The modular design provides the user with the flexibility to add power meters or mainframes for high channel count or high dynamic range applications. Testing of free space optics, such as, thin film filter (TFF) and waveguide alignment, are easily supported with the optical head. Its 5 mm detector and long, moveable reach provides the user with easy handling.

Active component test

High power amplifiers and sources are developed today in order to transmit signals over longer distances and to support a high loss environment for complex systems. High power measurements of +40 dBm, can be accomplished without an attenuator, which could add to the measurement uncertainty.

Optical component test in the visible wavelength range

For measuring visible and near-infrared light, like used in POS (polymer optical fiber) networks, visible LED's or infrared remote control sources, the new 81623B Option E01 external power head is an ideal solution. It covers the wavelength range from 450 to 1020 nm.

Research and calibration

Low measurement uncertainty of $< \pm 2.5\%$ and low PDL of $< \pm 0.005$ dB are a couple of the key features found in the Keysight power sensors. All of Keysight's power meter products are NIST and PTB traceable to guarantee precise optical power measurements. All metrology labs are ISO 17025 certified to meet general requirements for the competence of testing and calibration laboratories.

The instruments can log up to 20 k points with sampling times down to 100 μ s, or even 100 k points at 25 μ s with the 81636B. These samples can be triggered by the tunable laser for swept-wavelength spectral measurements. Built-in routines are also included for measuring maximum and minimum power, stability over extended time, and offset from an initial measurement value. Results can be displayed in mW, dBm, or dB change.

Selection criteria for optical power meters (see also page 38)

Optical power sensors

- 81635A: Dual-channel sensor, lowest price
- 81634B: Most accurate sensor, highest sensitivity
- 81636B: Fast power sensor, 100 k points, 25 μ s averaging, higher dynamic range during logging
- 81630B: Highest power sensor

Optical power heads

- 81620B Silicon head, 450-1020 nm
- 81623B: Ge head, general purpose, also specified for 850 nm
- 81624B: InGaAs head, highest accuracy
- 81626B: InGaAs head, high power with high relative accuracy
- 81628B: InGaAs head with integrating sphere, highest power and an accuracy at high power

	Keysight 81635A	Keysight 81634B	Keysight 81630B
Wavelength range	800 to 1650 nm	800 to 1700 nm	970 to 1650 nm
Power range	-80 to +10 dBm	-110 to +10 dBm	-70 to +28 dBm
Applicable fiber type	Standard SM and MM up to 62.5 μ m core size, NA \leq 0.24	Standard SM and MM up to 100 μ m core size, NA \leq 0.3	Standard SM and MM up to 100 μ m core size, NA \leq 0.3
Uncertainty (accuracy) at reference conditions	Typ. < \pm 3 % (1200 to 1630 nm) \pm 3.5 % (800 to 1200 nm)	\pm 2.5 % (1000 to 1630 nm)	\pm 3.0 % for 1255 to 1630 nm at 980 nm \pm 3.5 % (add \pm 0.5% per nm if 980 nm is not the center wavelength) at 1060 nm \pm 4.0 % (add \pm 0.6% per nm if 1060 nm is not the center wavelength)
Total uncertainty	Typ. \pm 5.5% \pm 200 pW (800 to 1200 nm) \pm 5% \pm 20 pW (1200 to 1630 nm)	\pm 4.5% \pm 0.5 pW (1000 to 1630 nm)	\pm 5 % \pm 1.2 nW (1255 to 1630 nm) at 980 nm \pm 5.5 % \pm 1.2 nW (add \pm 0.5% per nm if 980 nm is not the center wavelength) at 1060 nm \pm 6.0 % \pm 1.2 nW (add \pm 0.6 % per nm if 1060 nm is not the center wavelength)
Relative uncertainty – due to polarization – spectral ripple (due to interference)	Typ. < \pm 0.015 dB Typ. < \pm 0.015 dB	< \pm 0.005 dB < \pm 0.005 dB	< \pm 0.01 dB < \pm 0.005 dB
Linearity (power) – at 23°C \pm 5°C – at operating temp. range	CW -60 to +10 dBm Typ. < \pm 0.02 dB (800 to 1200 nm) < \pm 0.02 dB (1200 to 1630 nm) Typ. < \pm 0.06 dB (800 to 1200 nm) < \pm 0.06 dB (1200 to 1630 nm)	CW -90 to +10 dBm < \pm 0.015 dB (1000 to 1630 nm) < \pm 0.05 dB (1000 to 1630 nm)	CW -50 to +28 dBm (970 to 1630 nm) \leq \pm 0.05 dB \leq \pm 0.15 dB
Return loss	> 40 dB	> 55 dB	> 55 dB
Noise (peak to peak)	Typ. < 200 pW (800 to 1200 nm) < 20 pW (1200 to 1630 nm)	< 0.2 pW (1200 to 1630 nm)	< 1.2 nW (1255 to 1630 nm)
Averaging time (minimal)	100 μ s	100 μ s	100 μ s
Analog output	None	Included	Included
Maximum safe input power	> +16 dBm	+16 dBm	28.5 dBm
Dimensions (H x W x D)	75 mm x 32 mm x 335 mm (2.8" x 1.3" x 13.2")	75 mm x 32 mm x 335 mm (2.8" x 1.3" x 13.2")	75 mm x 32 mm x 335 mm (2.8" x 1.3" x 13.2")
Weight	0.5 kg	0.5 kg	0.6 kg
Recommended recalibration period	2 years	2 years	2 years
Operating temperature	+10 °C to + 40 °C	0 °C to + 45 °C	0 °C to + 35 °C
Humidity	Non-condensing	Non-condensing	Non-condensing
Warm-up time	20 min	20 min	20 min

Keysight 81636B	
Sensor element	InGaAs
Wavelength range	1250 to 1640 nm
Power range	-80 to +10 dBm
Applicable fiber type	Standard SM and MM up to 62.5 μ m core size, NA \leq 0.24
Uncertainty (accuracy) at reference conditions	\pm 3 % (1260 to 1630 nm)
Total uncertainty	\pm 5% \pm 20 pW (1260 to 1630 nm)
Relative uncertainty – Due to polarization – Spectral ripple (due to interference)	Typ. \pm 0.015 dB Typ. \pm 0.015 dB
Linearity (power) – At 23°C \pm 5°C – At operating temperature range	CW -60 to +10 dBm, (1260 to 1630 nm) < \pm 0.02 dB < \pm 0.06 dB

Keysight 81636B continued	
Return loss	> 40 dB
Noise (peak to peak)	< 20 pW (1260 to 1630 nm)
Averaging time (minimal)	25 μ s
Dynamic range at manual range mode	
at +10 dBm-range	Typ. > 55 dB
at 0 dBm-range	Typ. > 55 dB
at -10 dBm-range	Typ. > 52 dB
at -20 dBm-range	Typ. > 45 dB
Noise at manual range mode (peak to peak)	CW -60 to +10 dBm, 1260 to 1630 nm
at +10 dBm-range	< 50 nW
at 0 dBm-range	< 5 nW
at -10 dBm-range	< 1 nW
at -20 dBm-range	< 500 pW
Analog output	Included
Dimensions (H x W x D)	75 mm x 32 mm x 335 mm (2.8" x 1.3" x 13.2")
Weight	0.5 kg
Recommended recalibration period	2 years
Operating temperature	+10 °C to +40 °C
Humidity	Non-condensing
Warm-up time	20 min

	Keysight 81623B	Keysight 81623B Cal Opt C85	Keysight 81623B Cal Opt C01	Keysight 81620B (Si Detector)
Applicable fiber type standard open beam		SM and MM max 100 μ m core size, NA 0.3; Parallel beam max \varnothing 4 mm		
Sensor element		Ge, \varnothing 5 mm		Si, \varnothing 5mm
Wavelength range		750 to 1800 nm		450 to 1020 nm
Power range		-80 to +10 dBm		-90 to +10 dBm
Uncertainty at reference conditions	\pm 2.2% (1000 to 1650 nm) \pm 3.0% typ (800 to 1000 nm)	\pm 2.2% (1000 to 1650 nm) \pm 2.5% (800 to 1000 nm)	\pm 1.7% (1000 to 1650 nm) \pm 3.0% (800 to 1000nm)	\pm 2.2% (600 to 1020 nm) ^[1]
Total uncertainty	\pm 3.5% \pm 100 pW (1000 to 1650 nm) \pm 4.0% typ. \pm 250 pW (800 to 1000 nm)	\pm 3.5% \pm 100 pW (1000 to 1650 nm) \pm 3.7% \pm 250 pW (800 to 1000 nm)	\pm 3.0% \pm 100 pW (1000 to 1650 nm) \pm 4.0% typ. \pm 250 pW (800 to 1000 nm)	\pm 4% \pm 0.5 pW (600 to 1020 nm) ^[2]
Relative uncertainty				
- Due to polarization		< \pm 0.01 dB (typ. < \pm 0.005 dB)		n/a
- Spectral ripple (due to interference)		< \pm 0.006 dB (typ. < \pm 0.003 dB)		n/a
Linearity (power)		(CW -60 to +10 dBm)		(CW -70 to +10 dBm)
- At 23°C \pm 5°C		< \pm 0.025 dB		Typ. \pm 0.04 dB
- At operating temp. range		< \pm 0.05 dB		Typ. \pm 0.15 dB
Return loss		> 50 dB, typ. > 55 dB		n/a
Noise (peak to peak)		< 100 pW (1200 to 1630 nm) < 400 pW (800 to 1200 nm)		< 0.5 pW (700 to 900 nm)
Averaging time (minimal)		100 μ s		
Analog output		Included		
Maximum safe input power		+16 dBm		
Dimensions (H x W x D)		57 mm x 66 mm x 156 mm		
Weight		0.5 kg		
Recommended recalibration period		2 years		
Operating temperature		0 to 40 °C		
Humidity		Non-condensing		
Warm-up time		40 min		

1. Reference conditions:

- Power level 10 W (-20 dBm), continuous wave (CW)
- Parallel beam, 3 mm spot diameter on the center of the detector
- Ambient temperature 23 °C \pm 5 °C
- On day of calibration (add \pm 0.3% for aging over one year, add \pm 0.6% over two years)
- Spectral width of source < 10 nm (FWHM)
- Wavelength setting at power sensor must correspond to source wavelength \pm 0.4 nm

2. Operating conditions:

- Parallel beam, 3 mm spot diameter on the center of the detector or connectorized fiber with NA \leq 0.2 (straight connector)
- Averaging time 1s
- For NA > 0.2: add 1%
- Within one year after calibration, add 0.3% for second year
- Spectral width of source < 10 nm (FWHM)
- Wavelength setting at power sensor must correspond to source wavelength \pm 0.4 nm

	Keysight 81624B	Keysight 81624B Cal Opt. C01	Keysight 81626B	Keysight 81626B Cal Opt. C01
Sensor element	InGaAs, \varnothing 5 mm		InGaAs, \varnothing 5 mm	
Wavelength range	800 to 1700 nm		850 to 1650 nm	
Power range	-90 to +10 dBm		-70 to +27 dBm (1250 to 1650 nm) -70 to +23 dBm (850 to 1650 nm)	
Applicable fiber type Open beam	Standard SM and MM max 100 μ m core size, NA \leq 0.3 Parallel beam max \varnothing 4 mm		Standard SM and MM max 100 μ m core size, NA \leq 0.3 Parallel beam max \varnothing 4 mm	
Uncertainty at reference conditions	\pm 2.2 % (1000 to 1630 nm)	\pm 1.5 % (970 to 1630 nm)	\pm 3.0 % (950 to 1630 nm)	\pm 2.5 % (950 to 1630 nm)
Total uncertainty	\pm 3.5% \pm 5 pW (1000 to 1630 nm)	\pm 2.8% \pm 5 pW (970 to 1630 nm)	\pm 5.0% \pm 500 pW (950 to 1630 nm)	\pm 4.5% \pm 500 pW, (1250 to 1630 nm, max 27 dBm)
Relative uncertainty - Due to polarization - Spectral ripple (due to interference)	\leq \pm 0.005 dB (typ. \pm 0.002 dB) \leq \pm 0.005 dB (typ. \leq \pm 0.002 dB)		\leq \pm 0.005 dB (typ. \pm 0.002 dB) \leq \pm 0.005 dB (typ. $<$ \pm 0.002 dB)	
Linearity (power) - At 23 \pm 5 $^{\circ}$ C - At operat. temp. range	CW -70 to +10 dBm, 1000 to 1630 nm $<$ \pm 0.02 dB $<$ \pm 0.05 dB		CW -50 to +27 dBm, 950 to 1630 nm $<$ \pm 0.04 dB $<$ \pm 0.15 dB	
Return loss typ.	60 dB		$>$ 45 dB	$>$ 47 dB
Noise (peak to peak)	$<$ 5 pW		$<$ 500 pW	
Averaging time (min.)	100 μ s		100 μ s	
Analog output	Included		Included	
Maximum safe input power	+16 dBm		+23.5 dBm (850 to 1250 nm) / +27.5 dBm (1250 to 1650 nm)	
Dimensions (H x W x D)	57 mm x 66 mm x 156 mm		57 mm x 66 mm x 156 mm	
Weight	0.5 kg		0.5 kg	
Recommended recalibration period	2 years		2 years	
Operating temperature	0 to 40 $^{\circ}$ C		0 $^{\circ}$ C to +35 $^{\circ}$ C	
Humidity	Non-condensing		Non-condensing	
Warm-up time	40 min		40 min	

Keysight 81628B with Integrating Sphere

Sensor element	InGaAs		
Wavelength range	800 to 1700 nm		
Power range	-60 to +40 dBm (800 to 1700 nm), For operation higher than 34 dBm ¹		
Damage power	40.5 dBm		
Applicable fiber type / open beam	Single mode NA \leq 0.2, Multimode NA \leq 0.4 / \varnothing \leq 3 mm center of sphere		
Uncertainty at reference conditions	\pm 3.0 % (970 to 1630 nm)		
Total uncertainty	(970 to 1630 nm) \pm 4.0% \pm 5 nW		
\leq 10 dBm	\pm 4.5%		
$>$ 10 to \leq 20 dBm	\pm 5%		
$>$ 20 to \leq 38 dBm			
Relative uncertainty - Due to polarization - Due to speckle noise at source linewidth:	Typ. \leq 0.006 dB		
0.1 to 100 pm	Typ. $<$ \pm 0.02 dB		
$>$ 100 pm	Typ. $<$ \pm 0.002 dB		
Linearity (power) \leq 10 dBm $>$ 10 to \leq 20 dBm $>$ 37 to \leq 38 dBm	(CW -40 to +38 dBm), (970 to 1630 nm) \leq \pm 0.03 dB \leq \pm 0.09 dB \leq \pm 0.10 dB		
	At 23 $^{\circ}$ C \pm 5 $^{\circ}$ C, for operating temperature range add \pm 0.03 dB		
Return loss	Typ. $>$ 75 dB	Noise (peak to peak)	$<$ 5 nW
Averaging time (minimal)	100 μ s	Analog output	Included
Dimensions (H x W x D)	55 mm x 80 mm x 250 mm	Operating temperature	0 to +40 $^{\circ}$ C
Weight	0.9 kg (without heat sink)	Humidity	Non-condensing
Recommended recalibration period	2 years	Warm-up time	40 min

1. For optical power higher than 34 dBm the attached heat sink MUST be used! For continuous optical power or average optical power higher than 38 dBm the connector adapters will get warmer than permitted according to the safety standard IEC 61010-1. The 81628B Optical Head can handle optical power up to 40 dBm, however, operation above 38 dBm is at the operator's own risk. Keysight Technologies Deutschland GmbH will not be liable for any damage caused by an operation above 38 dBm.

www.keysight.com/find/oct

- Single module for return loss (RL) test
- High dynamic range of 75 dB
- -in Fabry-Perot laser source for 1310 and 1550 nm
- Use any external laser source, including tunable laser for swept RL applications
- Three easy calibration steps for enhanced accuracy



Meeting manufacturing needs

The need for IL and RL for optical component tests is fulfilled with the RL module when used with an optical power meter - preferably an optical head due to its flexibility. On-board application software supports step-by-step operation with instructions.

Swept RL measurement with tunable laser source

Today's passive component devices are not only characterized at a single wavelength, but over a wide wavelength range using a tunable laser source. The swept wavelength measurement concept is applicable for RL measurements using a Keysight tunable laser source (TLS) in synchronous operation of the two modules. The N7700A-100 PDL software supports use of the return loss modules as well.

Plug&Play for RL measurement

Portability and cost effective; a single mainframe, single module and single connection to the device under test are all you need to make a return loss (RL) measurement. Keysight's RL test solution solves the complex operation of calibration and is able to exclude measurement uncertainties due to coupler/filter usage in your design. In addition, a built-in FP laser at 1310 and 1550 nm enables basic component tests.

	81610A		81613A	
Source	External input only		Fabry-Perot laser (internal)	
Output power	-		Typ. -4 dBm	
Center wavelength	-		1310 nm/1550 nm ± 20 nm typ.	
Sensor element	InGaAs		InGaAs	
Fiber type	Standard single-mode 9 / 125 μm		Standard single-mode 9/125 μm	
External input	Max input power: 10 dBm Min input power: 0 dBm Damage input power: 16 dBm		- - -	
Wavelength range for external input	1250 to 1640 nm		-	
Dynamic range	70 dB		75 dB	
Relative uncertainty of return loss (RL)	With broadband source	With Keysight FP sources	User calibration	Plug&play
RL ≤ 55 dB	< ± 0.25 dB	Typ. < ± 0.5 dB	< ± 0.5 dB (typ. < ± 0.3 dB)	typ. < ± 0.6 dB
RL ≤ 60 dB	< ± 0.3 dB	Typ. < ± 1.0 dB	< ± 0.6 dB (typ. < ± 0.4 dB)	typ. < ± 1.5 dB
RL ≤ 65 dB	< ± 0.65 dB	Typ. < ± 2.0 dB	< ± 0.8 dB (typ. < ± 0.5 dB)	-
RL ≤ 70 dB	< ± 1.7 dB	-	< ± 1.9 dB (typ. < ± 0.8 dB)	-
RL ≤ 75 dB	-	-	typ. < ± 2.0 dB	-
Total uncertainty add	± 0.2 dB add	typ. ± 0.2 dB	Add ± 0.2 dB	Add typ. ± 0.2 dB
Dimensions (H x W x D)	75 mm x 32 mm x 335 mm (2.8" x 1.3" x 13.2")		75 mm x 32 mm x 335 mm (2.8" x 1.3" x 13.2")	
Weight	0.6 kg		0.6 kg	
Recommended recalibration period	2 years		2 years	
Operating temperature	10 to 40 °C		10 to 40 °C	
Humidity	Non-condensing		Non-condensing	
Warm-up time	20 minutes		20 minutes	

N7781B Polarization Analyzer

www.keysight.com/find/pol



The Keysight N7781B is a compact high-speed polarization analyzer which provides comprehensive capabilities for analyzing polarization properties of optical signals. This includes representation of the State of Polarization (SOP) on the Poincaré Sphere (Stokes Parameter). The on-board algorithms together with the on-board calibration data ensure highly accurate operation across a broad wavelength range.

Due to its real time measurement capability (1 MSamples/s) the instrument is well suited for analyzing disturbed and fluctuating signals as well as for control applications requiring real time feedback of polarization information.

Analogue data output ports are provided, for example for support of control loops in automated manufacturing test systems.

Powerful User Interface and remote programming capabilities are provided by the Polarization Navigator software package of the N7700A Photonic Application Suite.

Key features:

- Measurement of Stokes Parameter (SOP)
- Measurement of degree of polarization (DOP)
- High-speed operation (> 1 MSamples/s)
- Analog output port for DOP/SOP data

Monitoring/Measurement application of

- State of Polarization (SOP), Stokes Parameter
- Degree of Polarization (DOP)
- High-Speed Analysis of SOP/DOP of Recirculating Signal

Instrument setup: Polarization analyzer setup

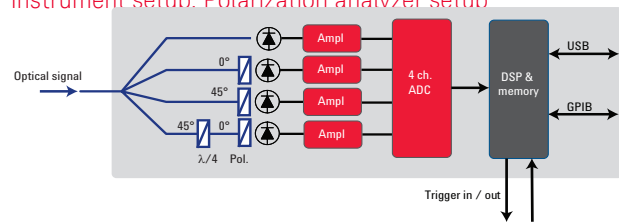

The instrument setup of the Keysight N7781B polarization analyzer is shown in the figure above. It consists of a unique polarimeter optics and a high-speed sampling subsystem. The measurement principle is based on splitting the light into four sub beams which are filtered through different polarizers. The resulting four power levels are evaluated using on-board calibration data to obtain an accurate SOP- and DOP-measurement.

N7781B Polarization Analyzer ¹

Wavelength

Specification wavelength range	1270 to 1375 nm (Opt 300, O-band) 1270 to 1375 nm, 1460 to 1620 nm (Opt 400, O/C/L-band) 1460 to 1620 nm (Opt 500, C/L-band)
--------------------------------	--

Operating wavelength range ²	1260 to 1640 nm
---	-----------------

Polarization analysis

SOP uncertainty ^{3,4} (typ.), DOP uncertainty ³	1.5° / ± 2.0%
---	---------------

DOP uncertainty after user calibration ^{3,5} (typ.)	± 0.5%
--	--------

Maximum sampling rate	Up to 1 MHz
-----------------------	-------------

Optical power measurement

Relative power uncertainty ³	C/L-band: ± 0.03 dB (± 0.02 dB typ.), O-band: ± 0.07 dB (± 0.04 dB typ.)
---	---

Input power range	-50 to +7 dBm
-------------------	---------------

Maximum safe optical input power	+12 dBm
----------------------------------	---------

1. Ambient temperature change max. ± 0.5°C since normalization. Specification valid on day of calibration.
2. SOP/DOP measurements are possible outside the specification wavelength range if a manual user calibration is performed.
3. Input power > -30 dBm
4. DOP > 95%
5. User calibration requires a source with DOP = 100%. User calibration is valid for a fixed wavelength.

www.keysight.com/find/pol



Keysight's N7782B series of PER analyzers has been designed for high speed and highly accurate testing of the polarization extinction ratio (PER) in PM fibers. The polarimetric measurement principle guarantees reliable measurements of PER values of up to 50 dB.

The real time measurement capability in combination with automation interfaces makes this unit ideally suited for integration in manufacturing systems, for example pig-tailing stations for laser diodes and planar waveguide components. Analog interfaces are provided for integration of the system in control loop applications.

Key benefits

- Accurate PER-measurement up to 50 dB
- Real-time display of PER
- Easy-to-use: Reliable results independent of operator skill set
- Swept-wavelength and heating/stretching method available
- Measurement of the PER versus wavelength
- Fast/slow axis detection
- Instruments available for 1260 up to 1640 nm
- Internal fixed wavelength sources at 850 nm/1310 nm/1550 nm available

Applications

- **Laser diode PMF pig-tailing** Alignment of the PM fiber during the pig tailing process is supported by real-time display of the PER and the optical power
- **PMF splicing** In order to support the alignment during the splicing process of PM fibers the Keysight N7782B provides real time display of the optical power and of the angular misalignment of the two fibers
- **PM component characterization** measurement of the PER on PM components like fiber polarizers, PMF couplers, PMF splitters, etc.
- **Characterization of PMF cross-coupling** polarization crosstalk in a PM fiber is measured and displayed as PER
- **PM splice characterization** The angular misalignment of a PM splice can be measured in a non-destructive way. Even multiple splices in a chain can be characterized independently.

Keysight N7782B and N7783B application examples

The wavelength scanning method

Using Keysight's tunable laser source 81600B series in combination with the Keysight N7782B PER analyzer allows measuring the PER as a function of wavelength.

The heating/stretching method

The heating/stretching method provides accurate measurements of the PER at a single wavelength. This method supports in particular well the measurement using narrow-band laser sources. An optional internal laser source allows stand-alone operation of the system.

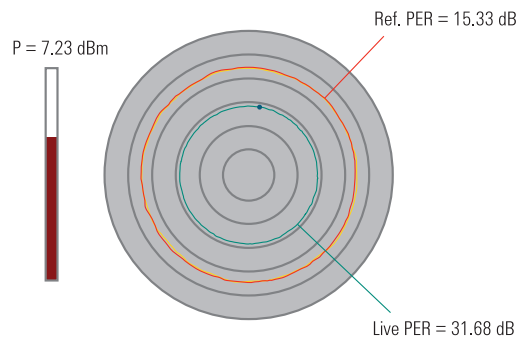

Keysight's thermal cycling unit N7783B is fully controlled by the Keysight N7782B PER analyzer and allows accurate and repeatable cycling of the temperature of the fiber under test. The PER measurement system consisting of the Keysight N7782B and the Keysight N7783B shows excellent accuracy and repeatability. Ease of use and automation interfaces, such as analog output ports for active alignment, make it particularly useful for production environments.

N7783B thermal cycling unit

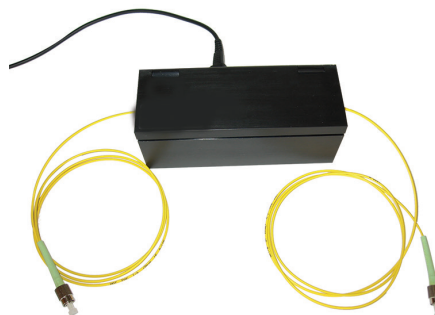

For characterizing an optical connection between two polarization maintaining fibers (PMFs), such as an optical splice, two thermal cycling units (Keysight N7783B) can be used. This eliminates the influence of input polarization or subsequent fibers at the output and isolates the angular misalignment of the connection located between the two thermal cycling units.

Specifications ¹ N7782B PER Analyzer**Wavelength**

Specification wavelength range	1270 to 1375 nm (Opt 300, O-band) 1270 to 1375 nm, 1460 to 1620 nm (Opt 400, O/C/L-band) 1460 to 1620 nm (Opt 500, C/L-band)
Operating wavelength range ²	1260 to 1640 nm (Opt 300/400/500)

PER analysis

PER range ^{3,4}	0 to 50 dB	
PER uncertainty, single-TCU method (typ.) ^{3,4}	PER = 0 to 30 dB	0.30 dB
	PER = 30 to 50 dB	0.60 dB

Splice angle analysis

Splice angle uncertainty, dual-TCU method (typ.) ^{3,4}	$\pm (0.1^\circ + 4\% \times \text{angle})$
---	---

Optical power

Input power range	-50 to +7 dBm (Opt 300/400/500)
Relative power uncertainty ³	C/L-band: ± 30 mdB (± 20 mdB, typ.) O-band: ± 70 mdB (± 40 mdB, typ.)

Internal laser source

Wavelength	Opt. 401 (O-band): 1290 to 1360 nm, 1310 nm typ. Opt. 501, 401 (C-band): 1510 to 1580 nm, 1550 nm typ.
Output power ⁵ (typ.)	Opt. 401 (O-band): -12 dBm Opt. 501, 401 (C-band): -10 dBm

1. Ambient temperature change max. $\pm 0.5^\circ\text{C}$ since normalization. Specification valid on day of calibration.
2. PER measurements are possible outside the specification wavelength range if the user performs a manual calibration. Note that a fully polarized light source is needed for calibration.
3. Input power > -30 dBm
4. Narrow-band light source with DOP $> 95\%$ needed.
5. At room temperature.

N7783B Thermal Cycling Unit Characteristics

Fiber jacket diameter	Up to 3 mm
Ambient temperature range	20 to 30 °C
Minimum peak-to-peak temperature tuning range	50 K
Power	100 to 240 VAC, < 36 W
Dimensions (H x W x D)	64 mm x 160 mm x 61 mm

www.keysight.com/find/pol



N7784B



N7785B



N7786B

These 3 instruments are all based on high-speed solid state optics to rapidly switch the polarization of an incoming signal. They are used with polarized input signals from lasers and can adjust, scan or align the output state of polarization. The instruments are controlled from an external PC and convenient graphical user interface control is provided with the included Polarization Navigator software, distributed with the N7700A Photonic Application Suite. Automated control is provided by the GPIB and USB interfaces.

N7785B Synchronous scrambler

The N7785B Synchronous scrambler provides fast SOP switching in response to internal or external triggering. This supports optical network simulations that often require switching of the signal SOP in a random way within a few microseconds, such as in recirculating loop tests. The SOP is switched rapidly, and then held for a predefined time until it again switches to a new SOP. The output SOP is controlled but not determined by the N7785B and will be changed if the input SOP changes. The output SOP can be adjusted to a desired external condition, such as

maximizing the signal through a polarizer. Application routines in the Polarization Navigator software can be used for random scrambling and continuous scrambling (where the state of polarization moves smoothly about the Poincaré sphere, similar to a flipper-style scrambler) over a wide range of speeds as for fast SOP-change tolerance testing of coherent receivers.

N7784B Polarization controller

The N7784B Polarization controller provides alignment and fast stabilization of SOP into polarization maintaining fiber (PMF) or with respect to an external condition by adding an analog feedback and polarizer path to the basic N7785B configuration.

For alignment into PMF, the input signal is first routed through the fast switching controller with single-mode fiber (SMF) and is available at an intermediate front panel output. An external jumper fiber is used to route the signal into the polarizer path consisting of a polarizing beam splitter with one output monitored by a photodetector. The other output is coupled to the front panel output with PMF. The signal from the photodetector is used to actively align and stabilize the input signal into the PMF output that could then be connected to a modulator or other polarization dependent device. Similarly, the signal can be used directly from the intermediate output and a user-configured setup can provide the feedback for optimizing the desired SOP from the instrument.

N7786B Polarization synthesizer

The N7786B Polarization synthesizer includes internal SOP monitoring and feedback via a tap coupler to determinately set and hold any chosen states or sequences of polarization. This allows generation of sequences with chosen relative SOP orientation. This is often used for component analysis based on Mueller Matrix or Jones Matrix analysis. The uniquely fast switching supports the new single-sweep spectral PDL measurements with the N7700A software, which eliminates sensitivity to environmental stability and minimizes measurement time. Analysis of these results into transmission spectra of the primary device axes (like TE and TM) is also achieved in this way. The real-time monitoring and logging of output SOP permits accurate calculation including the wavelength dependence of the SOP.

The real-time monitoring and feedback also are used in this instrument to provide stabilized SOP, even with fluctuation and drift of the input SOP.

The output SOP can be defined in following ways:

- Set-and-forget: When the front panel button is pushed, the current SOP is stored and maintained, even if polarization changes occur at the instrument input
- Defined Stokes: The target output SOP can be defined by the user using the Stokes parameters

The Polarization Navigator also has a convenient button to quickly change from a manually adjusted SOP to the corresponding orthogonal state, as can be used to check extinction ratio.

Specifications ¹ N7784B Polarization Controller**Wavelength**

Operating wavelength range Wavelength range in stabilizer mode ²	1260 to 1640 nm 1520 to 1580 nm
---	-----------------------------------

Polarization control and stabilization

SOP switching time (open-loop)	< 10 μ s
--------------------------------	--------------

PER at PMF output (typical)	> 23 dB
-----------------------------	---------

Stabilizer response time ³ (typ.)	2 ms
--	------

Optical power

Insertion loss port I \rightarrow port II ⁴ Insertion loss port III \rightarrow port IV ⁵	< 3.5 dB (< 3.0 dB, typ.) < 1.8 dB (< 1.4 dB, typ.)
---	---

PDL port I \rightarrow port II (typ.)	< 0.2 dB (C/L-band), < 0.5 dB (O-band)
---	--

Maximum safe input power	Port I: 20 dBm, Port III: 3 dBm
--------------------------	---------------------------------

Input power range in stabilizer mode	Port III: -30 to 0 dBm
--------------------------------------	------------------------

1. Ambient temperature change max. ± 0.5 °C since normalization. Specification valid on day of calibration;
2. Outside the stabilizer wavelength range, the PER at PMF Output may be degraded;
3. Input power at Port III > -30 dBm, response to an immediate step of 180° on the Poincaré sphere;
4. For SOP scrambling/switching, only ports I/II are used;
5. Valid for optimum input polarization at PBS input (Port III). Add insertion loss of port I/II and III/IV to obtain total insertion loss for SOP stabilizing mode.

Specifications ¹ N7785B Synchronous Scrambler**Wavelength**

Operating wavelength range	1260 to 1640 nm
----------------------------	-----------------

Polarization control

SOP switching time	< 10 μ s
--------------------	--------------

Optical power

Insertion loss	< 3.5 dB (< 3.0 dB, typ.)
----------------	---------------------------

PDL (typ.)	< 0.2 dB (C/L-band), < 0.5 dB (O-band)
------------	--

Maximum safe input power	20 dBm
--------------------------	--------

1. Ambient temperature change max. ± 0.5 °C since normalization. Specification valid on day of calibration

Specifications ¹ N7786B Polarization Synthesizer**Wavelength**

Specification wavelength range	1270 to 1375 nm, 1460 to 1620 nm (Opt 400, O/C/L-band) 1460 to 1620 nm (Opt 500, C/L-band)
--------------------------------	---

Operating wavelength range ²	1260 to 1640 nm
---	-----------------

Polarization control and stabilization

SOP switching time (non deterministic) SOP cycling time ⁶	< 10 μ s < 25 μ s
--	-----------------------------

Remaining SOP error after deterministic SOP setting (typ.) ⁷	< 3° / < 6.5° at input SOP movement rate of 1.2 rad/s / 40 rad/s
---	--

Polarization analysis

SOP uncertainty ^{3,4}	1.5°
--------------------------------	------

DOP uncertainty ³ DOP uncertainty after user ^{3,5} calibration (typ.)	$\pm 2.0\%$ $\pm 0.5\%$
---	---------------------------

Optical power measurement

Relative power uncertainty ³	C/L-Band: ± 0.14 dB (± 0.12 dB typ.), O-band: ± 0.16 dB (± 0.14 dB typ.)
---	--

Input power range	-38 to +19 dBm
-------------------	----------------

Optical power

Insertion loss	< 4.0 dB (< 3.5 dB, typ.)
----------------	---------------------------

PDL (typ.)	< 0.2 dB (C/L-band), < 0.5 dB (O-band)
------------	--

Maximum safe input power	20 dBm
--------------------------	--------

1. Ambient temperature change max. ± 0.5 °C since normalization. Specification valid on day of calibration.
2. SOP/DOP measurements are possible outside the specification wavelength range if the user performs a manual calibration.
3. Input power > -20 dBm.
4. DOP > 95%.
5. User calibration requires a source with a 100% DOP.
6. The instrument adaptively finds the polarization controller settings to let the SOP cycle through user-defined polarization states (closed loop operation). After having found these settings, the SOP can cycle through the polarization states in open loop operation.
7. This value is defined to be 5 times the standard deviation of the angular SOP error on the Poincaré sphere. Valid if controller is turned on. Power at instrument input > -10 dBm.

- Precise manual and remote adjustments of polarization state
- Nine Save/Recall registers of SOP
- Continuous auto scanning, tuning the SOP across the entire Poincare sphere



Polarization sensitive devices include EDFAs, single-mode fiber, polarization maintaining fiber, isolators, switches, lasers, couplers, modulators, interferometers, retardation plates and polarizers. Device performance will be affected by polarization-dependent efficiency, loss, gain and polarization mode dispersion. These polarization phenomena enhance or degrade performance depending on the application area, be it communications, sensors, optical computing or material analysis.

An Important Part of a Measurement System

A polarization controller is an important building block of an optical test system because it enables the creation of all possible states of polarization. The polarized signal stimulates the test device while the measurement system receiver monitors the test device's responses to changing polarization. Sometimes polarization must be adjusted without changing the optical power. At other times, polarization must be precisely synthesized to one state of polarization (SOP) and then adjusted to another SOP according to a predetermined path.

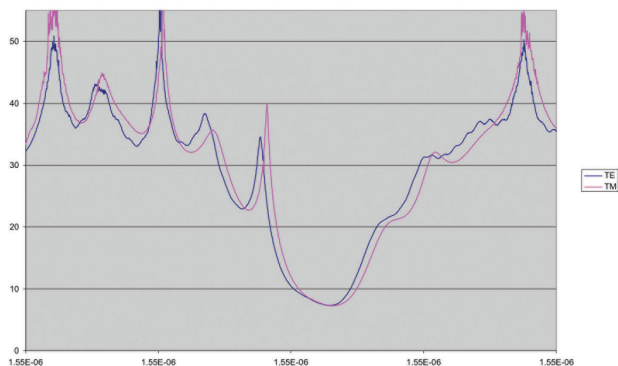

Characterizing the polarization-dependent wavelength shift of a passive optical component

The Keysight 8169A Polarization Controller

The 8169A Polarization Controller, with single-mode fiber input and output, is used to change light from any polarized or unpolarized light source into any well-defined state of polarization. The design based on bulk-optic zero-order waveplates and a high-performance linear polarizer at the input provides optimum determination and repeatability of polarization states over a wide wavelength range.

The 8169A has long been used together with a tunable laser to make swept-wavelength measurements of the polarization dependence of fiberoptic devices, by setting a set of relatively orthogonal polarization states for Mueller Matrix analysis and making separate sweeps for each state. These measurements are supported by the N4150A Photonic Foundations Library software package. This method is still supported, but the single-sweep method using the N7786B and N7700A PDL software generally provide a faster and more robust solution.

The fundamental basis of this flexible instrument also supports many general applications requiring polarization control and analysis. The high extinction ratio and simple stable optics make this an excellent tool for polarization nulling arrangements, finely adjusting the polarization for minimal transmission through a polarizer or polarizing beam splitter.

Specifications

Specifications describe the instruments' warranted performance over the 0 °C to +55 °C temperature range after a one-hour warm-up period. Characteristics provide information about non-warranted instrument performance. Specifications are given in normal type. Characteristics are stated in *italicized* type. Spliced fiber pigtail interfaces are assumed for all cases except where stated otherwise.

Operating Wavelength Range	1400 to 1640 nm
Insertion Loss	< 1.5 dB
Variation over 1 full rotation	< ± 0.03 dB
Variation over complete wavelength range	< ± 0.1 dB
Polarization Extinction Ratio	45 dB (1530 to 1560 nm) > 40 dB (1470 to 1570 nm) > 30 dB (typ.) (1400 to 1640 nm)
Polarization Adjustment Resolution	0.18° (360°/2048 (encoder positions))
Fast axis alignment accuracy at home position	± 0.2°
Angular adjustment accuracy	minimum step size ± 0.09° greater than minimum step size < ± 0.5°
Settling time (characteristic)	< 200 ms
Memory Save/Recall registers	9
Angular repeatability after Save/Recall	± 0.09°
Number of scan rate settings	2
Maximum rotation rate	360°/sec
Maximum Operating Input Power Limitation	+23 dBm
Operating Port Return Loss (characteristic)	Total reflection – Individual reflections > 60 dB
Power Requirements	48 to 60 Hz 100/120/220/240 Vrms 45 VA max
Weight	9 kg (20 lb)
Dimensions (H x W x D)	10 x 42.6 x 44.5 cm 3.9 x 16.8 x 17.5 in



N7788B optical component analyzer

General information

Keysight Technologies pushes the limits of component measurements with the N7788B Component Analyzer. Its proprietary technology is comparable with the well-known Jones-Matrix-Eigenanalysis (JME) which is the standard method for measuring Polarization Mode Dispersion (PMD) or differential group delay (DGD) of optical devices. Compared to the JME, Keysight's new single scan technology offers a range of advantages:

A complete set of parameters:

- DGD/ PMD / PDL / 2nd order PMD
- Power / Loss
- TE / TM-Loss
- Principal States of Polarization (PSPs)
- Jones and Mueller Matrices

For measuring these parameters, the N7788B is used together with a Keysight continuous-sweep tunable laser like the 81600B or 81960A, and control is provided with the Polarization Navigator package of the N7700A Photonic Application Suite. The N7788B also provide the full polarization analysis functionality of the N7781B.

High measurement speed:

- Complete measurement across C/L-band in less than 10 seconds (no need to wait for many averages)
- Robustness against fiber movement/vibration and drift:
- Fixing fibers with sticky tape on the table or even operation on isolated optical table is not required!
- No limitation on optical path length of component
- The internal referencing scheme guarantees reliable and accurate measurements.

Applications

- Fiber characterization: SMF, PMF, DCF
- Passive component testing: Filters, isolators, circulators
- Dynamic component/module testing: OADM/ROADM
- Active component testing: EDFAs, SOAs, VOAs
- Link test: In-Channel measurements across amplifiers

Designed for the manufacturing floor

High throughput:

A complete analysis across the C and the L band is performed in less than 10 seconds!

Remote control:

Control of the instrument and application software with the COM interface provides powerful and convenient automation.

Report generation:

Generating PDF reports is supported. The content including layout is configurable by the user.

Real-time power readout:

High throughput measurement of non-connectorized components is supported by providing a real time power readout which enables fiber coupling of the new device.

Instrument setup and application examples

N7788B PMD/PDL component analyzer setup

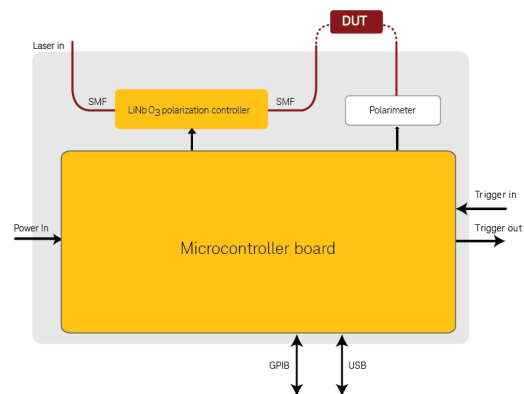

The instrument setup is shown in the figure above. A Lithium-Niobate polarization controller determines the input polarization to the DUT. While the tunable laser source¹ is sweeping over the desired wavelength range, a polarimeter analyzes the output state of polarization while input polarization is being modified. The result will be a highly accurate device characterization with respect to DGD/PDL/Loss etc. Furthermore, the internal optical switch provides continuous self calibration for excellent repeatability.

Resolving TE/TM insertion loss

The TE/TM-function allows accurate determination of the minimum and maximum loss of the DUT at each wavelength. Due to birefringence, optical filters tend to show different transmission functions depending on the polarization state.

Long term measurements

The capability of performing quick PMD-measurements makes this measurement system well-suited for collecting long-term PMD data. The PC software allows to continuously collect the spectral PMD data and store it on the hard disc. The data can then be visualized as pseudo-color plot (see figure).

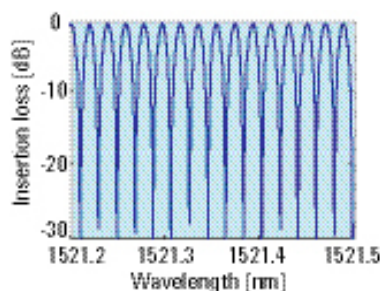
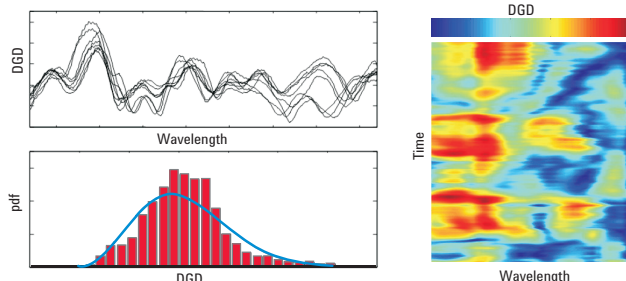

Excellent spectral resolution

Due to the excellent spectral resolution with the 81600B TLS, the Keysight N7788B is best suited for intra-channel DGD/PDL characterization. The All-Parameter-JME algorithm allows flexible adjustments of the wavelength resolution without the need to repeat the measurement. This simplifies finding the optimum trade-off between PDL/DGD accuracy and wavelength resolution.

Specifications ¹ N7788B Optical Component Analyzer

Wavelength

Specification wavelength range	1270 to 1375 nm (Opt 300, O-band) 1270 to 1375 nm, 1460 to 1620 nm (Opt 400, O/C/L-band) 1460 to 1620 nm (Opt 500, C/L-band)
--------------------------------	--

Operating wavelength range ²	1260 to 1640 nm
---	-----------------

Differential delay

DGD uncertainty ³	Resolution 2.0 nm: $\pm (30 \text{ fs} + 3.0\% \times \text{DGD})$ Resolution 0.1 nm: $\pm (30 \text{ fs} + 3.0\% \times \text{DGD})$
------------------------------	--

DGD measurement range ³	0 to 1000 ps
------------------------------------	--------------

PMD uncertainty ⁴	$\pm (30 \text{ fs} + 2.0\% \times \text{PMD})$
------------------------------	---

PMD repeatability (typ.)	$\pm 3 \text{ fs}$
--------------------------	--------------------

PMD measurement range ⁴	0 to 300 ps
------------------------------------	-------------

Loss

PDL uncertainty ⁵	C/L-band: $\pm (0.05 \text{ dB} + 4\% \times \text{PDL})$
------------------------------	---

	O-band: $\pm (0.10 \text{ dB} + 4\% \times \text{PDL})$
--	---

PDL repeatability (typ.)	$\pm 0.005 \text{ dB}$
--------------------------	------------------------

Insertion loss uncertainty (typ.) ³	C/L-band: $\pm 0.03 \text{ dB}$
--	---------------------------------

	O-band: $\pm 0.07 \text{ dB}$
--	-------------------------------

Insertion loss dynamic range (typ.) ³	> 41 dB (for TLS power levels higher than -6 dBm, increase value accordingly)
--	---

Polarization analysis

See N7781B specifications

Optical power measurement

See N7781B specifications

1. Ambient temperature change max. $\pm 0.5^\circ\text{C}$ since normalization. Valid for 81600B tunable laser source family. Tunable laser power set to -6 dBm. Sweep over specification wavelength range. Specification does not include instability in test device. Specified loss ranges include loss of test device and any additional switches or connections in the optical path. Specification valid on day of calibration.
2. SOP/DOP measurements are only possible outside the specification wavelength range if the user performs a manual calibration.
3. DUT properties: Insertion Loss < 30 dB, PDL < 1 dB, DGD < 150 ps. Specification is typical for DGD > 150 ps.
4. DUT properties: Insertion Loss < 41 dB, PDL < 3 dB, PMD < 50 ps. Applies for highly mode-coupled devices such as single mode fibers. Specification applies for PMD being the averaged DGD over a wavelength span of 100 nm. Specification is typical for PMD > 50 ps.
5. DUT properties: Insertion Loss < 25 dB, PDL < 6 dB. Note: DUT connectors are considered being part of the DUT. Thus, angled connectors will add to the device PDL.

NEW

www.keysight.com/find/mwm

- New 86120D replaces 86120B and 86120C, providing faster measurements and better accuracy from 700 - 1650 nm
- Characterize WDM spectra during R&D and manufacturing
- Wavelength accuracy $< \pm 0.3$ pm with 0.5 s update rate
- Simultaneously measure wavelengths and powers of up to 1000 channels
- Automatic optical signal-to-noise ratio measurements
- Automated measurement routines and data logging

As the demand for access to more information increases, the need for greater capacity on transmission systems drives component manufacturers and network equipment manufacturers to push their capabilities to new limits. The use of tunable transmitters and ROADMs in networks makes accurate and fast measurements of wavelength more critical than ever. With Keysight multi-wavelength meters, you will be able to address these demands with confidence.



The Performance You Need – When You Need It

The Keysight family of multi-wavelength meters is just that – a family. Each model uses compatible SCPI remote commands. You pay for only the performance you need, when you need it. If your requirements become more demanding in the future, you can substitute another Keysight multi-wavelength meter, avoiding unnecessary cost and time developing new code for your test system. With the 86122C, you can upgrade to a unit with the best performance available. Keysight multi-wavelength meters allow you to optimize test costs while protecting your investments.

Simultaneously measure up to 1000 wavelengths and powers

The Keysight 86120D and 86122C multi-wavelength meters, like other, Michelson interferometer-based wavelength meters, allow you to measure the average wavelength of the input signal. In addition, the Keysight multi-wavelength meters – with advanced digital processing – accurately and easily differentiate and measure up to 1000 discrete wavelengths.

Keysight multi-wavelength meters simultaneously measure the individual powers of discrete wavelengths, offering the following measurement capabilities:

- 1 to 1000 wavelengths and powers
- Average wavelength and total power
- Up to ± 0.2 ppm wavelength accuracy
- Up to 5 GHz wavelength resolution
- Calibrated for evaluation in air or vacuum
- Wavelength units in nm, THz, or wave number (cm⁻¹)
- Amplitude units in dBm, mW, or μ W
- Rugged design to withstand strong shocks and vibrations

WDM transmission systems

Combining measurement performance with reliability, the Keysight multi-wavelength meters allow easy and accurate verification of optical carrier performance in transmission systems by measuring wavelength, power and optical signal-to-noise ratios during design and manufacturing test. The 86122C multi-wavelength meter is optimized for measuring ultra-dense channel spacing with an absolute wavelength accuracy of up to ± 0.2 ppm (± 0.3 pm referenced to 1550 nm). With a resolution of < 5 GHz, it is an ideal solution for the design and manufacturing of next-generation optical networks.

Sources

The superior wavelength and amplitude measurement capabilities of the Keysight 86120D and 86122C multi-wavelength meters enable maximum performance of your components. You can measure DFB, FP, iTLA or multiple DFB laser wavelengths and amplitudes during burn-in, environmental evaluation, mode mapping, final test and incoming inspection. Calculate center wavelengths of broader linewidth sources, such as LED's or Bragg-Gratings filtered ASE responses, or modulated sources, using the user-selectable broadband algorithm.

Features and advanced measurement applications:

- Relative Wavelength and Amplitude Measurements
- Built-in Data Logging
- Drift: Current and Min/Max values
- Optical Signal-To-Noise Ratio
- Fabry-Perot Laser Characterization
- Broadband signal mode

Instrument drivers

Instrument drivers compatible with LabView, Visual Basic, C++, and LabWindows are available for the Keysight 86120D and 86122C multi-wavelength meters. These drivers enable remote program development by offering building blocks that allow you to customize your measurements.

86120D and 86122C Multi-Wavelength Meters



www.keysight.com/find/mwm

		86120D	86122C
Maximum number of laser lines input		1000	
Wavelength	Range	700 to 1650 nm (182 to 428 THz)	1270 to 1650 nm (182 to 236 THz)
	Operating range	700 to 1700 nm (176 to 428 THz)	
	Absolute accuracy	± 1.5 ppm, typ. 1 ppm (within 15°C to 35°C) (± 2.3 pm at 1550 nm, ± 2.1 pm at 1310 nm) for laser lines separated by ≥ 20 GHz	± 0.2 ppm (± 0.3 pm at 1550 nm and 1310 nm); for laser lines separated by ≥ 10 GHz
	Differential accuracy ¹ minimum resolvable separation (equal power lines input)	± 0.4 ppm 15 GHz (0.12 nm at 1550 nm, 0.09 nm at 1310 nm)	± 0.15 ppm 5 GHz (0.04 nm at 1550 nm; 0.03 nm at 1310 nm)
	Display resolution	0.0001 nm	
Units	nm (vacuum or standard air), cm ⁻¹ , THz		
Power	Calibration accuracy	± 0.6 dB (at ± 30 nm from 780, ¹ 1310, and 1550 nm)	± 0.5 dB (at ± 30 nm from 1310 and 1550 nm)
	Flatness ¹ , 30 nm from any wavelength	± 0.2 dB, 1200 to 1600 nm ± 0.5 dB, 700 to 1650 nm	± 0.2 dB, 1270 to 1600 nm ± 0.5 dB, 1270 to 1650 nm
	Linearity, lines above -30 dBm	± 0.3 dB, 1200 to 1600 nm	± 0.3 dB, 1270 to 1600 nm
	Polarization dependence	± 0.6 dB, 1200 to 1600 nm ± 1.5 dB ¹ , 700 to 1650 nm	± 0.6 dB, 1270 to 1600 nm ± 1.0 dB ¹ , 1600 to 1650 nm
	Units	dBm, mW, μW	
Sensitivity¹	Single line input	-20 dBm, 700 to 900 nm -25 dBm ¹ , 800 to 1200 nm -40 dBm, 1200 to 1600 nm -30 dBm, 1600 to 1650 nm	-32 dBm, 1270 to 1600 nm -22 dBm, 1600 to 1650 nm
	Multiple lines input ¹	30 dB below total input power, but not less than single line	
Selectivity		25 dB spacing ≥ 100 GHz 10 dB spacing ≥ 25 GHz	25 dB spacing ≥ 90 GHz 10 dB spacing ≥ 10 GHz
	Measurement cycle time	0.6 s	0.5 s (86122C-100) 0.3 s (86122C-110)
Input power	Maximum displayed level	+10 dBm (sum of all lines input)	
	Maximum safe input level	+18 dBm (sum of all lines input)	
Built-in automatic measurement applications			
	Signal-to-noise ratio, 100 averages, at 1550 nm, 0.1 nm noise bandwidth, lines above -25 dBm ¹	> 35 dB, channel spacing ≥ 200 GHz	> 35 dB, channel spacing ≥ 100 GHz > 27 dB, channel spacing ≥ 50 GHz
	Drift	Maximum, Minimum, total drift (max-min) wavelengths and powers over time	
	Fabry-Perot characterization ¹	Mean wavelength, peak wavelength, mode spacing full-width half maximum, peak amplitude, total power, sigma	
Reliability	Recommended re-calibration period	2 years	2 years
Laser classification		FDA Laser Class I according to 21 CFR 1040.10; IEC Laser Class 1 according to IEC 60825-1/2007	
Dimensions		138 mm x 425 mm x 520 mm	
HxWxD		(5.4 in x 16.7 in x 20.5 in)	
Weight		14.5 kg (32 lb)	

1. Supplementary performance characteristics provide information about non-warranted instrument performance in the form of nominal values.
 2. For lines separated by less than the specified amount, wavelength accuracy is reduced.

8157xA High-Power Optical Attenuators

www.keysight.com/find/voa

- Low insertion loss of 0.7 dB
- Excellent wavelength flatness
- Coverage in both single mode and multi mode fiber
- High attenuation resolution of 0.001 dB
- Active power control option



Modular design, fit for various component and network solutions

Keysight's 8157xA variable optical attenuators are a family of plug-in modules for Keysight's lightwave solution platform 8163A/B, 8164A/B and 8166A/B. The attenuator modules 81570A, 81571A and 81578A occupy one slot, while modules 81576A and 81577A occupy two slots. With 17 slots, the Keysight 8166A/B lightwave multichannel system can host up to 17 single slot modules or up to 8 dual slot modules.

Variable optical attenuators

The Keysight 81570A, 81571A and 81578A are small, cost effective attenuator modules with high resolution. They feature excellent wavelength flatness and can handle high input power levels. Various calibration features allow the user to set a reference power. Both the attenuation and the power level, relative to the reference power, can then be set and displayed in the user interface. An integrated shutter, which can be used for protection purposes, or to simulate channel drops, is available.

Attenuators for high optical input power

The Keysight modules feature excellent wavelength flatness and can handle high input power levels of 2 mW. Combined with their low insertion loss, they are ideal for optical amplifier tests, such as characterization of EDFAs and of Raman amplifiers, as well as for other multi-wavelength applications, such as DWDM transmission system test.

Attenuators with power control

Keysight's 81576A and 81577A attenuators feature power control functionality that allows you to set the output power level of the attenuator. The attenuator module firmware uses the feedback signal from a photo diode after a monitor tap, both integrated in the module, to set the desired power level at the output of the module. When the power control mode is enabled, the module automatically corrects power changes at the input to maintain

the output level set by the user. After an initial calibration for the uncertainties at connector interfaces, absolute power levels can be set with high accuracy. The absolute accuracy of these power levels depends on the accuracy of the reference power meter used for calibration.

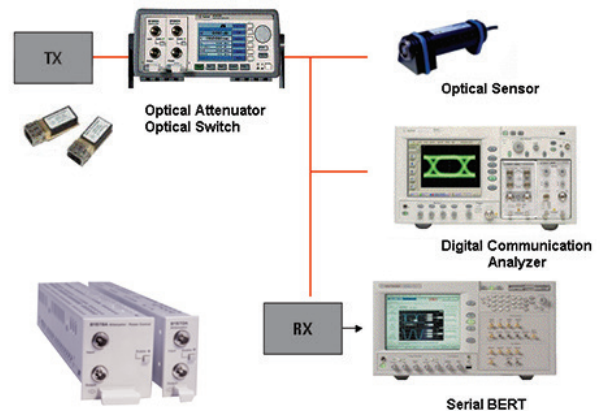

Transceiver and Receiver Test

Wavelength flatness

The Keysight optical attenuator modules feature excellent wavelength flatness and can handle high input power levels. Combined with their low insertion loss, they are ideal for optical amplifier tests, such as characterization of EDFAs and of Raman amplifiers, as well as for other multi-wavelength applications, such as DWDM transmission system test. One unique feature is a Plug&Play software function which enhances calibration capacity by setting the integral power of a DWDM signal with a known spectrum.

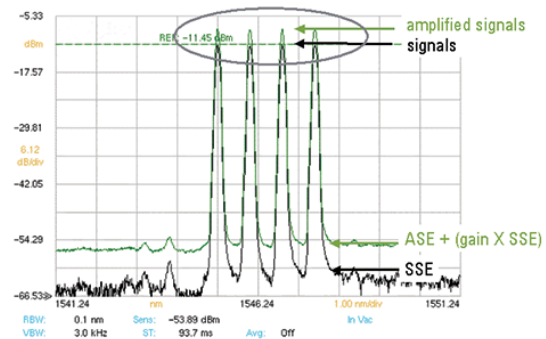

Wavelength flatness preserves multichannel signal flatness for EDFA test.

Modal fidelity for multimode fiber systems

Signals in multimode fibers are distributed over a range of mode groups that can have different loss and delay in a link. For dependable multimode transceiver testing, the instrument used to set the power level should not change this modal distribution. The bulk-optic filter and collimated beam path of Keysight multimode attenuators are the best way to assure homogeneous attenuation of all input modes.

	8157xA		81578A-050	81578A-062
Connectivity	Straight (81570A) / Angled (81571A) Flexible connector interface		Straight (81576A) / Angled (81577A) Flexible connector interface	
Fibre type	9/125 μ m SMF28		50/125 μ m MMF	62.5/125 μ m MMF
Wavelength range	1200 to 1700 nm		700 to 1400 nm	
Attenuation	0 to 60 dB		0 to 60 dB	
Resolution	0.001 dB		0.001 dB	
Repeatability ¹ (Attenuation setting)	0.01 dB		\pm 0.015 dB ^{13,15}	
Repeatability ¹ (Power setting)			\pm 0.015 dB ²	
Accuracy (uncertainty) ^{1,3} (Attenuation setting)	\pm 0.1 dB ^{4,5}		\pm 0.1 dB ^{4,5}	
Settling time (typ.) ²³ (Attenuation setting)	100 ms		100 ms	
Settling time (typ.) ²³ (Power setting)			100 ms	
Transition speed (typ.)	0.1 to 12 dB/s		0.1 to 12 dB/s	
Relative power meter uncertainty ^{16,17}	N/A		\pm 0.03 dB \pm 200 pW ¹⁶	
Attenuation flatness ^{1,5,7,9}	< \pm 0.07 dB (typ \pm 0.05 dB) for 1520 to 1620 nm typ. \pm 0.10 dB for 1420 to 1640 nm		N/A	
Spectral ripple (typ.) ⁸	\pm 0.003 dB		\pm 0.003 dB	
Insertion loss ^{3,5}	Typ. 0.7 dB (excluding connector) 1.6 dB typ. 1.0 dB (including connectors) ^{10,13}		Typ. 0.9 dB (excluding connectors) 1.8 dB typ. 1.2 dB (including connectors) ^{10,12}	
Insertion-loss flatness (typ.) ^{1,12,5}	\pm 0.1 dB for 1420 to 1615nm		Typ. 1.0 dB (NA = 0.1) Typ. 1.3 dB (NA = 0.2) 2.0 dB (NA = 0.2) ^{13,15} Typ. 3.0 dB (NA = 0.27)	
Polarization-dependent loss ^{3,10,12}	< 0.08 dBpp (Typ. 0.03 dBpp)		< 0.10 dBpp (typ. 0.05 dBpp)	
Return loss (typ.)	45 dB (81570A) / 57 dB (81571A) ^{10,12}		45 dB (81576A)/ 57 dB (81577A) ^{10,12}	
Maximum input power ¹⁴	+33 dBm		+33 dBm	
Shutter isolation (typ.)	100 dB		100 dB	
Dimensions (H x W x D)	75 mm x 32 mm x 335 mm (2.8" x 1.3" x 13.2")		75 mm x 32 mm x 335 mm (2.8" x 1.3" x 13.2")	
Weight	0.9 kg		1.3 kg	
Recommended recalibration period	2 years		2 years	
Operating temperature	10 to 45 °C		10 to 45 °C	
Humidity	Non-condensing		Non-condensing	
Warm-up time	30 minutes		30 minutes	

1. At constant temperature.

2. Output power > -40 dBm, input power < +27 dBm. For input power > +27 dBm add typ. \pm 0.01 dB.

3. Temperature within 23 \pm 5 °C.

4. Input power < +30 dBm; 1550 nm \pm 15 nm; typ. for 1250 nm < λ < 1650 nm.

5. For unpolarized light

6. Stepsize < 1 dB; for full range: typ. 6 s.

7. Relative to reference at 0 dB attenuation.

8. Linewidth of source \geq 100 MHz.

9. For λ_{disp} set to 1550 nm and attenuation \leq 20 dB; for higher attenuation add 0.01 dB per add. dB for 1520 to 1620 nm and 0.02 dB/dB for 1450 to 1640 nm.

10. For 1550 nm \pm 15 nm.

11. Add typ. 0.1 dB for 1310 nm \pm 15 nm.

12. Measured with Keysight reference connectors.

13. Effective spectral source bandwidth > 5 nm

14. For input mode conditions NA = 0.2; for additional Δ NA = 0.01, add \pm 0.01 dB typ.

15. At 850 \pm 15 nm or 1310 \pm 15 nm

Ordering information: For the most up-to-date information on Keysight optical attenuators, please contact your Keysight Technologies sales representative or visit our web site at: www.keysight.com/find/lightwave

Connector interface: All modules require two connector interfaces, 81000xl series (physical contact).

N775xA and N776xA Optical attenuators

- 0.05 dB relative power setting accuracy
- Settling time: 20 ms attenuation, 100 ms power, 200 ms multimode
- Miniature bulk optics for best multimode transfer distribution
- 0.1 to 1000 dB/s or for multimode to 0.1 to 80 and 1000 dB/s attenuation transition speed (selectable)
- +23 dBm max. input power
- ≤ 1.2 dB insertion loss
- 45 dB single-mode attenuation range (typ.)
- 35 dB multimode attenuation range
- -50 to +20 dBm power setting range
- Fully compatible with setups and programs developed using the Keysight 8157x modular attenuators
- Two instrument configurations can be stored and recalled

The Keysight N775xA and N776xA series compact multichannel attenuators and power meters are a new class of remote controlled fiber optic instruments for optical transceiver and network integration test. All attenuators include an internal power monitor for each channel to reduce the complexity of closed-loop setups like those needed for very accurate BER testing or eye mask analysis by allowing power to be set directly rather than needing to set an attenuation value. All attenuators feature both attenuation mode and power control mode: In attenuation mode, the calibrated value of attenuation in dB can be set. The rate of attenuation change during setting can be adjusted between 0.1 and 80 dB/s or set to 1000 for multimode and adjusted from 0.1 to 1000 dB/s for single mode. In power control mode, the instrument uses its integrated power monitor to set the desired power level at the output of the module. It automatically corrects for input power changes so that the output power level is maintained. Absolute power levels can be set with high accuracy after an initial offset calibration.

Modal fidelity for multimode fiber systems

Signals in multimode fibers are distributed over a range of mode groups that can have different loss and delay in a link. For dependable multimode transceiver testing, the instrument used to set the power level should not change this modal distribution. The bulk-optic filter and collimated beam path of Keysight multimode attenuators are the best way to assure homogeneous attenuation of all input modes.

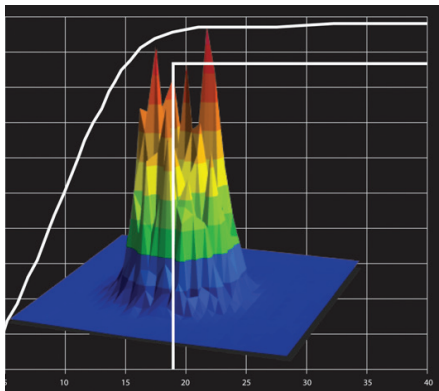

N776xA multi-channel optical attenuators with internal power control



1-channel variable attenuator N7761A



2-channel N7762A SMF attenuator or N7766A MMF attenuator



4-channel N7764A SMF attenuator or N7768A MMF attenuator

N775xA multi-channel optical attenuators with internal power control and external power meter channels.

The 2 integrated power meters in the N7751A and N7752A allow convenient measurement of optical power from different stages of the test setup and provide a very convenient and automatic way to calibrate the attenuator power reading to the power actually present at another point, such as the input to the receiver under sensitivity test. This calibration can thus correct for insertion loss due to switches and other components between the attenuator and the point of interest.



1-channel attenuator with two power meter channels N7751A



2-channel attenuator with two power meter channels N7752A

	N7751A, N7752A, N7761A, N7762A, N7764A		N7766A and N7768A	
Connectivity	FC/APC angled (Option -022) or FC/PC straight (Option -021) contact connector interface		FC/PC straight contact connector interface	
Fiber type	9/125 μ m SMF 28		50 μ m (Option 050) or 62.5 μ m (Option 062) or 80 μ m (Opt. 080) core MMF	
Wavelength range	1260 to 1640 nm		800 to 1370 nm	
Attenuation range	0 to 40 dB (45 dB typ.)		0 to 35 dB	
	Attenuation setting mode	Power setting mode	Attenuation setting mode	Power setting mode
Range	0 to 40 dB	-50 to +20 dBm	0 to 35 dB	-35 to +20 dBm
Resolution	0.01 dB	0.01 dB	0.03 dB	0.03 dB
Repeatability	Typ. \pm 0.05 dB for attenuation 0 to 30 dB Typ. \pm 0.10 dB for attenuation 30 to 40 dB	\pm 0.025 dB	\pm 0.05 dB	\pm 0.05 dB
Accuracy (uncertainty)	Typ. \pm 0.10 dB for attenuation 0 to 10 dB Typ. \pm 0.15 dB for attenuation 10 to 20 dB Typ. \pm 0.40 dB for attenuation 20 to 40 dB		Typ. \pm 0.40 dB	
Relative accuracy (uncertainty)	\pm 0.05 dB \pm 300 pW		\pm 0.1 dB \pm 300 pW	
Polarization dependent loss	Typ. \leq 0.15 dBpp for attenuation 0 to 10 dB Typ. \leq 0.25 dBpp for attenuation 10 to 20 dB Typ. \leq 0.5 dBpp for attenuation 20 to 40 dB		\leq 0.15 dBpp	
Settling time	Typ. 20 ms*	Typ. 100 ms*	Typ. 200 ms	Typ. 200 ms
Insertion loss	Typ. \leq 1.2 dB (excluding connectors) \leq 2.2 dB (including connectors)*		Typ. \leq 1.0 dB (excluding connectors) \leq 2.0 dB (including connectors)*	
Attenuation transition speed	Selectable from 0.1 to 1000 dB/s		Selectable from 0.1 to 80 or at > 500	
Relative uncertainty of monitor power meter	\pm 0.05 \pm 300 pW		\pm 0.1 \pm 300 pW	
Averaging time of monitor power meter	2 ms to 1 s		2 ms to 1 s	
Return loss	Typ. 45 dB		Typ. 25 dB	
Maximum safe input power	+23 dBm if applied to input port; or +18 dBm if applied to output port		+23 dBm	
	N7751A and N7752A			
Sensor element	InGaAs			
Wavelength range	1260 to 1640 nm			
Specification wavelength range	(1310 \pm 15) nm, (1490 \pm 10) nm, (1550 \pm 15) nm			
Power range	-80 to +10 dBm			
Maximum safe power	+16 dBm			
Averaging time	2 ms to 1 s			
Applicable fiber type	Standard SM and MM \leq 62.5 μ m core size, NA \leq 0.24			
Uncertainty at reference conditions	\pm 2.5%			
Total uncertainty	\pm 4.5%			
Linearity at (23 \pm 5) $^{\circ}$ C	\pm 0.02 dB			
Linearity* over operating temperature	\pm 0.04 dB			
Polarization dependent responsivity (PDR)	Typ. $<$ \pm 0.01 dB (1260 to 1580 nm)			
Spectral ripple (due to interference)	Typ. $<$ \pm 0.01 dB			
Drift (dark)	\pm 9 pW			
Noise pp (dark)3, (1 s averaging time, 300 s observation time)	$<$ 7 pW			
Return loss	Typ. $>$ 57 dB			

For the most up-to-date information on Keysight optical attenuators, please contact your Keysight Technologies sales representative or visit our web site at: www.keysight.com/find/lightwave

81595B, N7731A and N7734A Optical Switch

www.keysight.com/find/oct

- Excellent repeatability, specified over 10,000 random cycles
- Low insertion loss and polarization dependence
- Single-mode or multimode
- Single 1x4, dual 1x4 and single 1x13



Switching reduces uncertainty from connections and eases test automation

These instruments and modules are used for automatic routing of optical signals for testing devices like transceivers, amplifiers, and passive components. Optical switches optimize the investment in automated test equipment by improving repeatability and throughput and supporting parallel measurements of multipoint and multiple devices.

The low IL and PDL and high repeatability assure minimum impact of the switch on measurement accuracy.

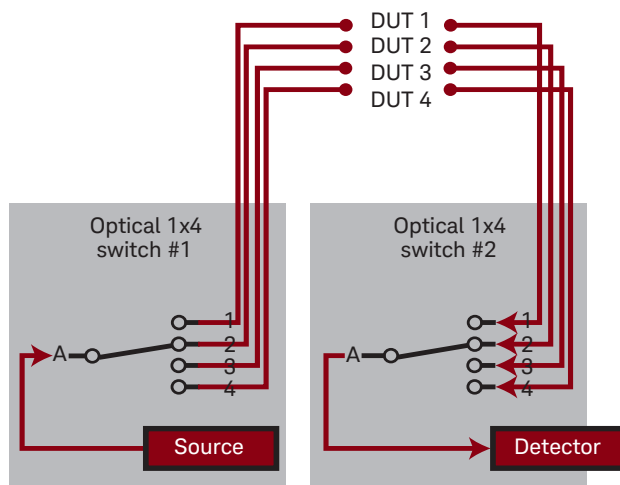

Switching can be performed from the button on the module, from the mainframe interface and via GPIB control. The compact form and high performance allow combining switches for multistage setups, like five 1x4 modules.

Modal fidelity for multimode fiber systems

Signals in multimode fibers are distributed over a range of mode groups that can have different loss and delay in a link. For dependable multimode transceiver testing, the instrument used to set the power level should not change this modal distribution. The Keysight multimode switches are designed with very short collimated paths between fiber, so signals propagate in practically the same distribution as through uninterrupted multimode fiber.

Modular optical switch specifications

81595B		
Switch type	1x4	
Fiber interface	# 009 single mode	# 062 multimode
Fiber type	9/125 μm SMF	62.5/125 μm MMF
Connectivity	FC/APC angled, narrow key	FC/PC straight
Wavelength range	1270 to 1670 nm	700 to 1400 nm
Repeatability ²	± 0.03 dB	± 0.03 dB
Insertion loss	< 1.25 dB	< 1.0 dB
Polarization dependent loss	typ. 0.07 dB _{pp}	N/A
Return loss	typ. 55 dB	typ. 20 dB
Crosstalk	typ. -70 dB	typ. -70 dB
Switching time	< 10 ms	
Lifetime	> 10 million cycles	
Maximum input power	+20 dBm	

N7731A		
Switch type	Dual 1x4	
Fiber interface	# 009 single mode	# 062 multimode
Fiber type	9/125 μm SMF	62.5/125 μm MMF
Connectivity	FC/APC angled, narrow key	FC/PC straight
Wavelength range	1250 to 1650 nm	600 to 1700 nm
Repeatability ²	± 0.01 dB, ± 0.004 dB typ.	± 0.01 dB ¹ , ± 0.004 dB typ.
Insertion loss	< 2.0 dB, < 1.5 dB typ.	< 1.0 dB ¹ , < 0.5 dB typ.
Polarization dependent loss	Typ. 0.07 dB _{pp}	N/A
Return loss	Typ. 55 dB	Typ. 35 dB
Crosstalk	Typ. -65 dB	Typ. -65 dB ⁴
Switching time	< 20 ms	
Lifetime	> 1 billion cycles	
Maximum input power	+23 dBm	

N7734A		
Switch type	1x13	
Fiber interface	# 009 single mode	# 062 multimode
Fiber type	9/125 μm SMF	62.5/125 μm MMF
Connectivity	FC/APC angled, narrow key	FC/PC straight
Wavelength range	1250 to 1650 nm	600 to 1700 nm
Repeatability ²	± 0.01 dB, ± 0.004 dB typ.	± 0.01 dB ¹ , ± 0.004 dB typ.
Insertion loss	< 2.5 dB, < 2.2 dB typ.	< 1.2 dB, < 0.7 dB typ.
Polarization dependent loss	Typ. 0.12 dB _{pp}	N/A
Return loss	Typ. 55 dB	Typ. 30 dB
Crosstalk	Typ. -60 dB	Typ. -55 dB
Switching time	< 20 ms	
Lifetime	> 1 billion cycles	
Maximum input power	+23 dBm	



The new N4373D offers the latest 5227A series network analyzers with 2-port or 4-port configuration. This LCA is the ideal measurement solution for test of electro-optical components up to 67 GHz. It is the ideal test instrument for electro-optical components for 56 Gbaud coherent transmission, as well as Radio over Fiber (RoF) and aerospace and defense (A&D) electro-optical test applications.

The N4373D is traceable to international standards and provides guaranteed specifications for electro-optical responsively S-parameter measurements in a turn-key solution. In combination with N4694A electronic calibration kit you get fastest setup of your test, so you can focus on developing your components.

Fast and easy measurement setup increases productivity as time-consuming electrical calibration steps are automated and optical calibration by the operator is no longer necessary.

Features

- Built-in average power meter for fast transmitter power test
- SCPI remote control
- PMF optical output for reliable modulator test
- User selectable optical transmitter output power helps to adapt to target test conditions

Absolute frequency response accuracy at 26.5 GHz

- < 0.9 dBe at 50 GHz (typ.)
- < 1.3 dBe at 67 GHz (typ.)

Relative frequency response accuracy at 26.5 GHz

- < 0.5 dBe at 50 GHz (typ.)
- < 1.3 dBe at 67 GHz (typ.)

Noise floor 26.5 GHz

- < -59 dB (W/A) at 67 GHz for E/O measurements
- < -55 dB (A/W) at 67 GHz for O/E measurements

Benefits

- Design assurance with fast, accurate and complete measurements
- Quick time-to-market with fast test turnaround
- Protected investment with flexibility to add and change options and wavelength range
- Efficient use of measurement time with intuitive and powerful user interface and measurements at the touch-of-a-button
- Confident and easy analysis with built-in smoothing and fitting tools
- High uptime with worldwide service and support Easy data transfer with LAN and USB connectivity
- Optimized use of time with programmable automation

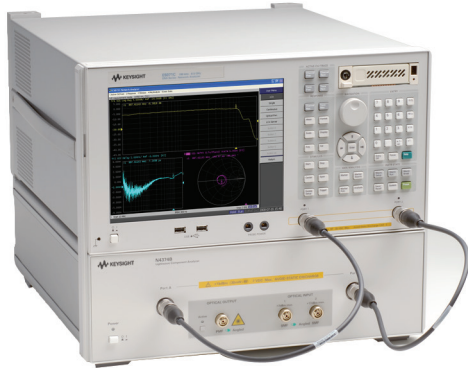

The new N4374B lightwave component analyzer (LCA) is the successor of the 8702 LCA with target application in CATV and Radio over Fiber (RoF). It is based on ENA-C series network analyzers. CATV is supported by offering a 75 Ω referenced measurement. To do this a minimum loss pad is included to adapt from 50 Ω to 75 Ω . With the adapter removal tool included in the ENA all test results show the correct 75 Ω referenced results.

With up to 4.5 GHz modulation frequency range electro-optical S-parameter tests for 3G and LTE RoF applications are well supported. Traceable specifications for relative and absolute responsivity make the tests results independent of the instrument personality that makes the test results comparable between supplier and vendor or between various locations.

It's the excellent accuracy and repeatability that improves yield from tests performed with the N4374B, by narrowing margins needed to pass the tested devices resulting in improved manufacturing yield. The turn-key solution offers fastest time to market. With the more than 3 times faster tests compared to the 8702 series this LCA helps to significant reduce manufacturing cost.

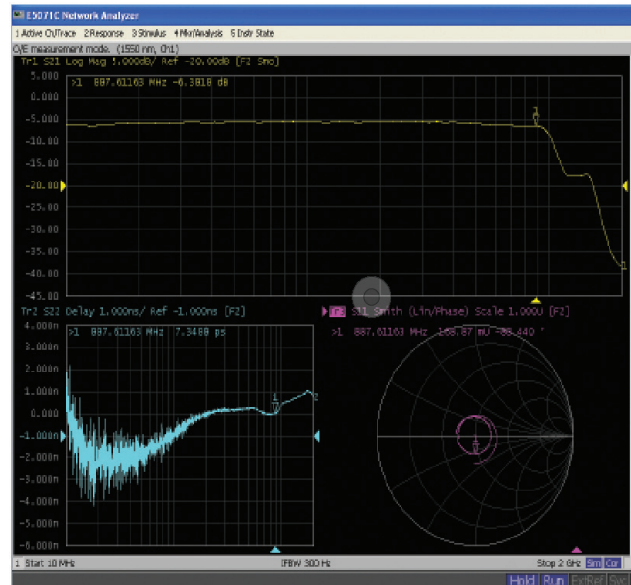

Key benefits

- High absolute and relative accuracy measurements improve the yield of development and production processes
- Support of 75 Ω devices
- Significantly increased productivity using fast and easy measurement setup with a unique new calibration process leads to lower cost of test
- Identical LCA software and remote control across the N437xB/C family simplifies integration
- Transmitter wavelength 1550 nm and/or 1310 nm
- Built-in optical power meter
- Settable transmitter output power
- External optical input option
- Integrated Bias-T option in ENA

System performance extract (typical data @1550 nm)		100 kHz to 0.7 GHz	0.7 GHz to 4.5 GHz
Relative frequency response uncertainty	E/O	± 0.7 dBe	± 0.5 dBe
	O/E	± 0.7 dBe	± 0.5 dBe
Absolute frequency response uncertainty	E/O	± 1.7 dBe	± 1.5 dBe
	O/E	± 1.7 dBe	± 1.5 dBe
Frequency response repeatability	E/O, O/E	± 0.02 dBe	± 0.02 dBe
Noise floor	E/O	-60 dB (W/A)	-80 dB (W/A)
	O/E	-50 dB (A/W)	-70 dB (A/W)
Phase uncertainty (typ.)	E/O	-	$\pm 2.0^\circ$
	O/E	-	$\pm 2.0^\circ$
Group delay uncertainty		Derived from phase uncertainty, see section "Group delay uncertainty". Example: $\pm 2.0^\circ \rightarrow \pm 8$ ps (1 GHz aperture)	

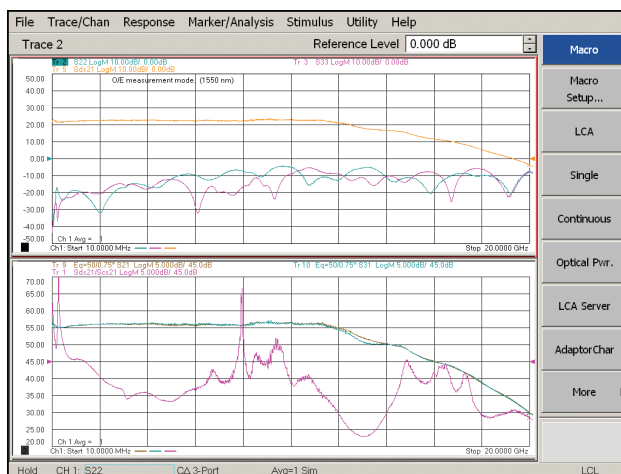

Keysight's N4375D lightwave component analyzer (LCA) is the successor of the industry standard 8703A/B LCA. Its target application is the test of electro-optical components for 10 GbE, Fibre Channel FCx8, FCx10 and FCx16.

With a completely new design of the optical test set and a new RF-switched architecture, together with the latest PNA family of network analyzers, the N4375D guarantees excellent electro-optical measurement performance. In addition a unique new calibration concept significantly reduces time from powering up the LCA until the first calibrated measurement can be made. This increases productivity in R&D and on the manufacturing floor.

The fully integrated "turnkey" solution reduces time to market, compared to the time-consuming development of a selfmade setup. By optimizing the electrical and optical design of the N4375D for lowest noise and ripple, the accuracy has been improved by more than a factor of 3 and is now independent of the electrical return loss of the device under test. It is the excellent accuracy that improves the yield from tests performed with the N4375D, by narrowing margins needed to pass the tested devices. NIST traceability ensures worldwide comparability of test results.

Key benefits

- High absolute and relative accuracy measurements improve the yield of development and production processes
- High confidence and fast time-to-market with a NIST traceable turnkey solution
- Significantly increased productivity using the fast and easy measurement setup with a unique new calibration process leads to lower cost of test
- More than 3 times faster than predecessor 8703A/B series speeds up every test procedure
- New switched architecture of optical test set for long term reliability and stability of test results
- Identical LCA software and remote control across the

System performance extract (typical data @1550 nm)

		0.05 GHz to 0.2 GHz	0.2 GHz to 0.7 GHz	0.7 GHz to 20 GHz
Relative frequency response uncertainty	E/O	± 0.7 dBe	± 0.5 dBe	± 0.5 dBe
	O/E	± 0.7 dBe	± 0.5 dBe	± 0.5 dBe
Absolute frequency response uncertainty	E/O	± 1.7 dBe	± 1.5 dBe	± 1.5 dBe
	O/E	± 1.7 dBe	± 1.5 dBe	± 1.5 dBe
Frequency response repeatability	E/O, O/E	± 0.02 dBe	± 0.02 dBe	± 0.05 dBe
Noise floor	E/O	-60 dB (W/A)	-86 dB (W/A)	-86 dB (W/A)
	O/E	-49 dB (A/W)	-72 dB (A/W)	-74 dB (A/W)
Phase uncertainty (typ.)	E/O	-	± 2.0°	± 2.0°
	O/E	-	± 2.0°	± 2.0°
Group delay uncertainty		Derived from phase uncertainty, see section "Group delay uncertainty". Example: ± 2.0° > ± 8 ps (1 GHz aperture)		

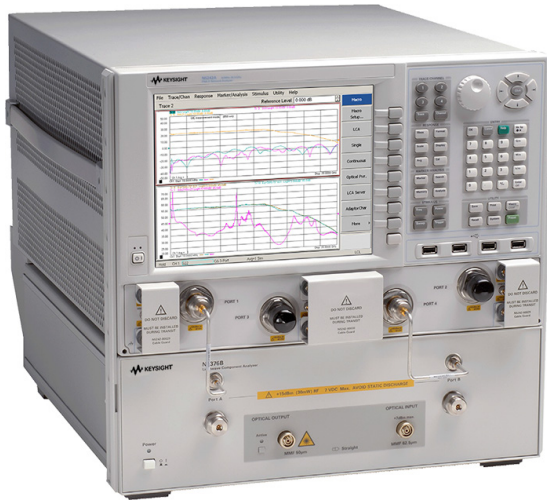

Keysight's N4376D multimode lightwave component analyzer (LCA) operates at 850 nm to characterize short wavelength 10 GbE, Fibre Channel FCx8, FCx10 and FCx16 electro-optical components, with up to 20 or 26.5 GHz modulation range. The N4376D also supports the test of transmitter and receivers for ultra fast optical computer or server backplanes and optical chip-to-chip connections in high speed computers and server applications. With a completely new design of the optical test set and a new RF-switched architecture, together with the latest PNA family of network analyzers, the N4376D guarantees excellent electro-optical measurement performance. In addition a unique new calibration concept significantly reduces time from powering up the LCA until the first calibrated measurement can be made. This increases productivity in R&D and on the manufacturing floor.

Multimode measurements are typically much more critical regarding repeatability and stability than single-mode measurements. A well defined and stable launch condition increases measurement repeatability. The N4376D has typical multimode launch conditions as defined by the IEEE 802.3ae standard, resulting in application realistic and repeatable test results.

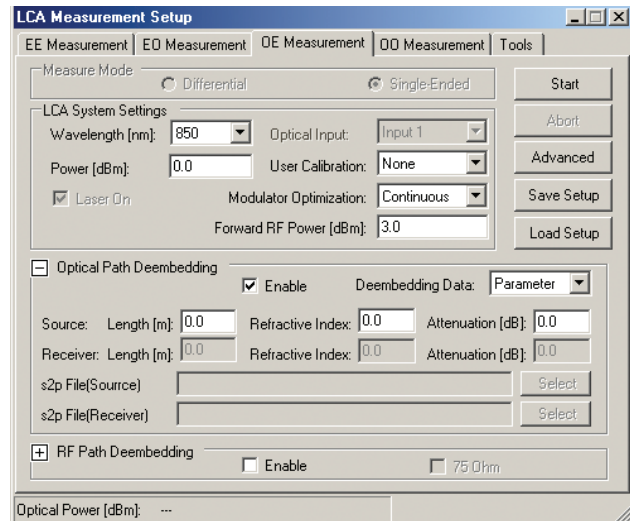

Key benefits

- Traceable multimode S21 test at 850 nm wavelength
- IEEE 802.3ae launch power distribution leads to test results comparable to the final application
- Fast and easy measurement setup and calibration for all standard tests
- High confidence and fast time-to-market with a traceable turn-key solution
- Significantly increased productivity using the fast and easy measurement setup with a unique new calibration process leads to lower cost of test
- Test right at target launch condition eliminates test uncertainty
- Identical LCA software and remote control across the N437xB/C family simplifies integration
- LC or SC straight connectors
- Built-in optical power meter for fast transmitter power verification
- Powerful remote control with state of the art programming interface based on Microsoft NET or COM
- Identical LCA software and remote control across the N437xx family simplifies integration

System performance extract (typical data @ 850 nm)

		0.05 GHz to 0.2 GHz	0.2 GHz to 10 GHz	10 GHz to 26.5 GHz
Relative frequency response uncertainty	E/O	± 1.3 dBe	± 1.3 dBe	± 1.6 dBe
	O/E	± 1.3 dBe	± 1.3 dBe	± 1.6 dBe
Absolute frequency response uncertainty	E/O	± 2.0 dBe	± 2.0 dBe	± 2.0 dBe
	O/E	± 1.7 dBe	± 2.0 dBe	± 2.0 dBe
Frequency response repeatability	E/O, O/E	± 0.2 dBe	± 0.1 dBe	± 0.1 dBe
Noise floor	E/O	-50 dB (W/A)	-70 dB (W/A)	-70 dB (W/A)
	O/E	-40 dB (A/W)	-60 dB (A/W)	-60 dB (A/W)

- Advanced research for 400 G / 1T and beyond
- Ideal for research on super-channels
- Full C and L-band support
- Based on 90000-Z series oscilloscopes with industry-leading signal integrity

- Polarization of analyzed symbols
- Support of more than 30 modulation formats
- Adaptive equalization
- Custom OFDM and Custom IQ demodulator available



Unlike the high-speed optical networks of the past, where modulating an optical wave's amplitude on and off at high rates was sufficient, today's optical links are following the wireless industry's lead to high order modulation formats. Complex modulation formats extend beyond on-off keying by encoding communication symbols with both amplitude and phase information. The N4391A optical modulation analyzer is optimized for analysis of these kinds of new optical modulation formats. It is the ideal instrument for advanced research on higher than 112 Gbit/s transmission speeds.

Features and benefits

- Wide-bandwidth time-domain polarization-diverse coherent optical receiver, for state-of-the-art advanced modulation format analysis
- Performance verification within minutes for highest reliability of your test results
- One SW platform for entire OMA portfolio
- Well defined interface to include your own MATLAB algorithms
- Fully calibrated system to reveal raw signal performance
- Real-time sampling for optimal phase tracking
- Highest flexibility, with numerous modulation formats, analysis tools and instrument configurations
- No clock input or hardware clock recovery necessary
- Long pattern analysis available
- Flexible hardware and software concept for future adoption to new requirements and investment protection
- CD and first order PMD measurement and compensation for link tests with vector modulated signals

Parameter	N4391A-110-Z33 Single Scope Single Testhead	N4391A-120-Z63 Single Scope Dual Testhead	N4391A-120-Z64 Dual Scope Dual Testhead	N4392A
Analog Bandwidth	4x 33 GHz	4x 33 GHz / 2x 63 GHz	4x 63 GHz	4x 23 GHz
EVM noise floor @ reference conditions	< 1.8 % rms	< 1.8 % rms	< 1.8 % rms	< 2.4 % rms
BW of opt. frontend (O/E)	4x 43 GHz	4x 56 GHz	4x 56 GHz	4x 23 GHz
Sample rate	4x 80 GSa/s	4x 80 GSa/s / 2x 160 GSa/s	4x 160 GSa/s	4x 63 GSa/s
Max symbol rate (DP / SP)	2x 64 GBd	2x 64 GBd / 1x 125 GBd	2x 125 GBd	2x 46 GBd
Sensitivity	- 20 dBm	- 18 dBm	- 18 dBm	- 22 dBm
Sample Memory	Up to 4x 2 GSa	Up to 4x 2 GSa	Up to 4x 2 Gsa	4x 16 kSa
Software platform	VSA/OMA 5.x			
Wavelength accuracy	+/- 5 pm	+/- 5 pm	+/- 5 pm	+/- 2 pm
Weight	~ 48 kg (106 lbs)	~ 63 kg (139 lbs)	~ 96 kg (212 lbs)	13 kg (28.7 lbs)
Portability	no	no	no	yes

N4392A Portable Optical Modulation Analyzer

www.keysight.com/find/n4392a

- 40/100/200 G coherent transmission test
- Coherent transmitter characterization
- Intradyme Coherent Receiver Test (ICR) test application
- CFP2-ACO test application
- Coherent transmission link test
- Error vector analysis capabilities
- Less than 13 kg (28.7 lbs.)
- Built-in calibration
- Built-in performance verification
- Built-in high-performance digitizer



You will no longer have to share an optical modulation analyzer among colleagues or even departments because of its high initial investment price.

You will no longer have to move your device under test to another location because it's too hard to move the analyzer, just to perform a short measurement.

You will no longer have to ship your optical modulation analyzer to service once a year for performance verification and recalibration. Now the instrument does all this for you whenever you think it is necessary, increasing the time you can use your instrument.

The N4392A is the next generation of optical modulation analyzers in a compact housing of a mid-size oscilloscope. With 15" screen size, even more analysis parameters can be visualized at the same time, leading to faster debugging results.

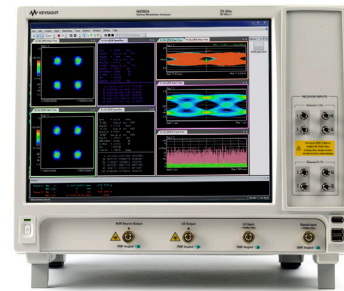

Compact

Integration of a digitizer, optics and analysis PC leads to a compact turn-key instrument. It also avoids any external cabling, making the instrument robust and easy to set up wherever needed.

Despite the smaller size, the new N4392A offers a big laptop-size screen, giving you more insight in your signal for understanding and debugging your signals even faster.

Portable

The integration in a compact mid-size oscilloscope housing results in a lightweight instrument, which can be easily moved to any location in a lab or on the manufacturing floor. Operators who need to analyze and debug signals at the physical layer will enjoy this feature as well.

Affordable

The N4392A is designed for best price-performance balance, achieved by combining advanced integration technologies with built-in calibration and performance verification tools. This leads to longer intervals between recalibration, extending uptime in research and manufacturing and resulting in reduced cost of ownership without leaving any doubt about the performance of the instrument.



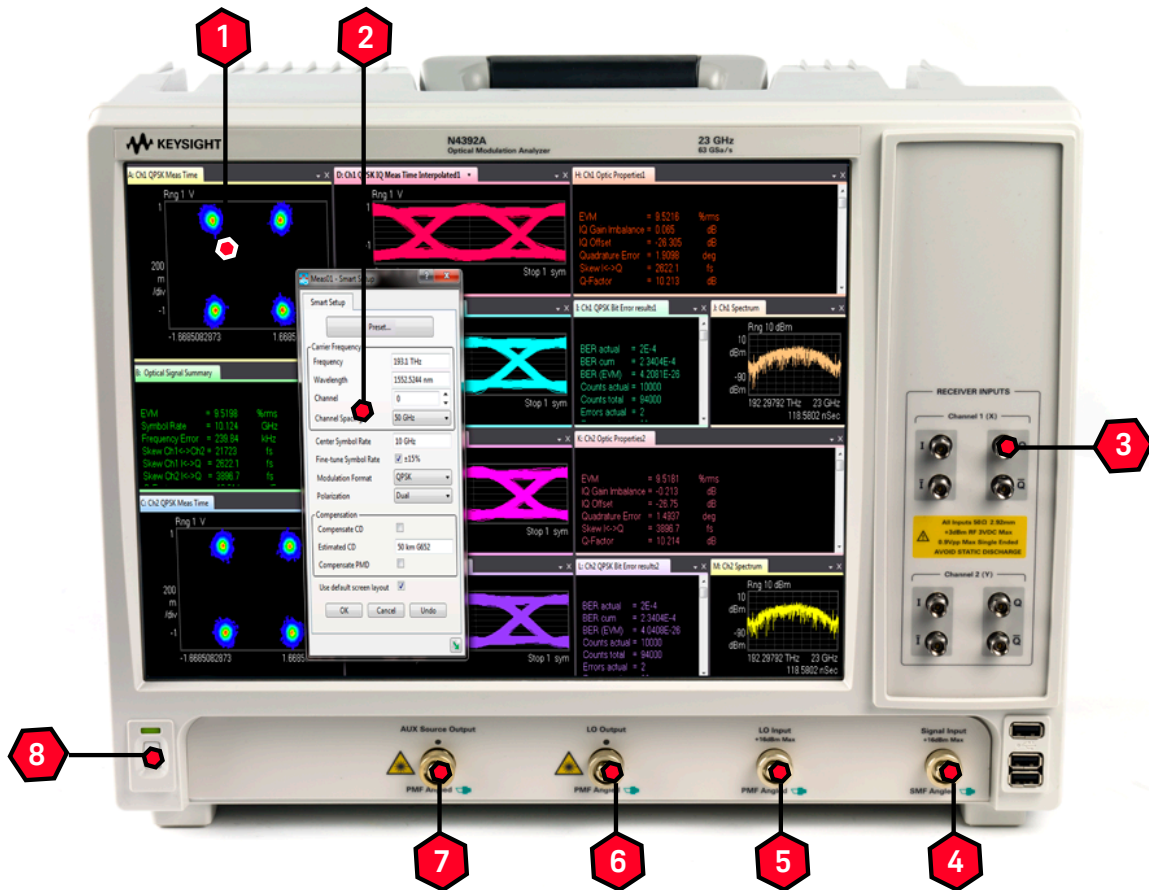

1. Vector signal analysis

Like the N4391A, the N4392A is based on the Keysight 89601B vector signal analysis software which is extended for optical requirements. One software platform ensures exchangeability of setting files and measurement results between R&D and manufacturing. This also makes results comparable and exchangeable.

2. Predefined setups

For easiest setup of standard 40 G, 100 G and 100 G modulation formats.

3. RF inputs

Characterize and evaluate your own IQ demodulator with four differential RF digitizer inputs as required for OIF compliant integrated coherent receivers. (Option 310)

4. Signal input

Feed in your signal under test at this input, for modulation analysis that gives you the highest confidence in your test results.

5. LO input

In experiments where an extremely stable local oscillator with linewidth in the low kHz range is required, this input can be used as Local oscillator (LO) input for external lasers. (Option 320)

6. LO output

Get part of the local oscillator signal to the output for monitoring or setting up a homodyne experiment. (Option 320)

7. AUX source output

This output (Option 320) provides you with a CW laser signal which can be used to drive your transmitter or use it as an auxiliary output to calibrate an external integrated IQ demodulator. (Option 320)

8. Power ON/OFF

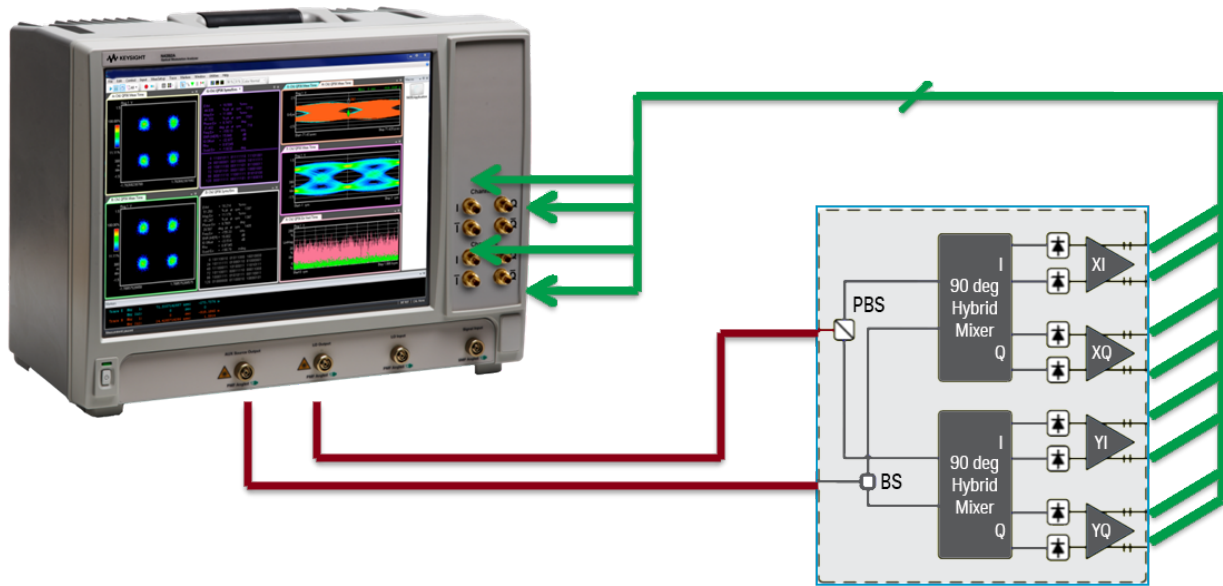

The test of an integrated intradyne coherent receiver (ICR) as defined by Optical Internetworking Forum requires many parameters to test for each device. These devices can be tested in the above illustrated setup quickly and easily. Again the EVM concept offers a powerful tool to verify the overall quality of an ICR within a second. This setup simulates a golden transmitter which has better performance than any production-series transmitter. Analyzing this signal in the same way as a normal

transmitter signal can reveal impairments that reflect the intrinsic performance of the ICR under test (see left screens in the screen shot below) and therefore indicates limitations to the performance that can be achieved.

In addition to the spectral display on the right screens, the image suppression gives you an indication of distortions in the system and shows how well balanced your photodiodes are.

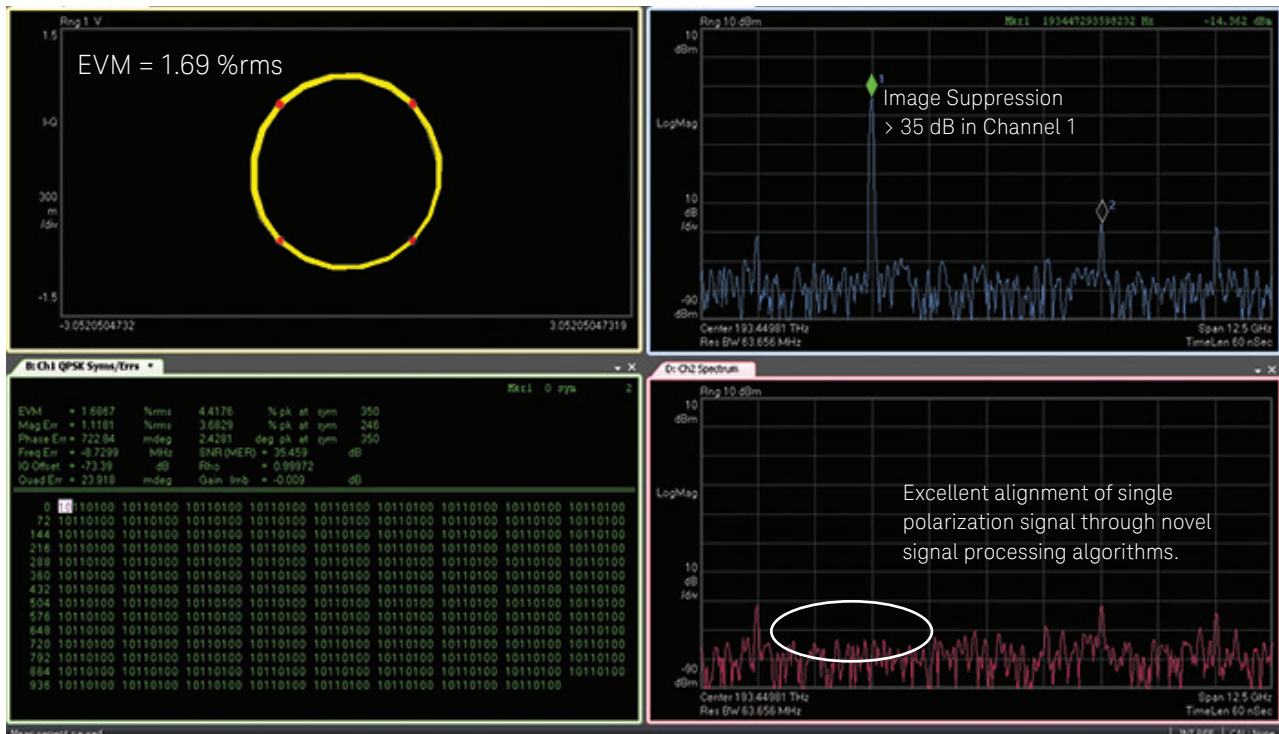

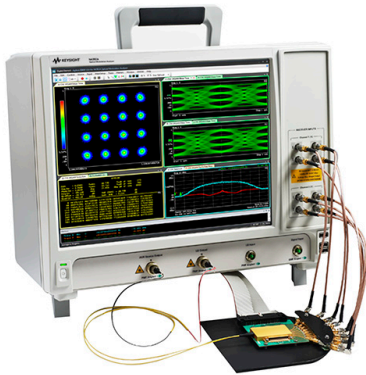

Test setup to verify performance of ICR

Integrated coherent receiver test

For detection of complex modulated optical signals OIF defined an electro-optical component typically described as integrated dual polarization intradyne coherent receiver (ICR). This component contains optical and electro-optical components in one package, as shown in the figure left as device under test.

The hybrid contains many components that need to be integrated and perform seamless as a black box coherent receiver.

The integrated component needs to be tested in research and in manufacturing.

The N4392A offers an application (Option 430), to test this kind of devices and extract parameters that characterize the behavior of the component.

With the N4392A it is possible to test the component in an environment that is identical to the final application providing highest confidence in the performance of the component:

- This test is performed with the N4392A by generating a beat signal within the detection band to the ICR optical inputs
- This test is an excellent setup to verify the intrinsic performance of the ICR as it reflects noise impairments and all kinds of distortions
- The IQ diagram gives an indication on the noise and the distortion of the signal of the ICR created from a nearly perfect beat signal. The same parameters that are used to quantify the signal quality (EVM, IQ offset, IQ imbalance, Quadrature error) can be used to qualify the intrinsic performance of the component
- Image suppression in a spectral display gives a good indication of presence of imbalances between channels and PIN diodes in the coherent receiver. A good image suppression and large common mode rejection ratio indicate a well balanced receiver

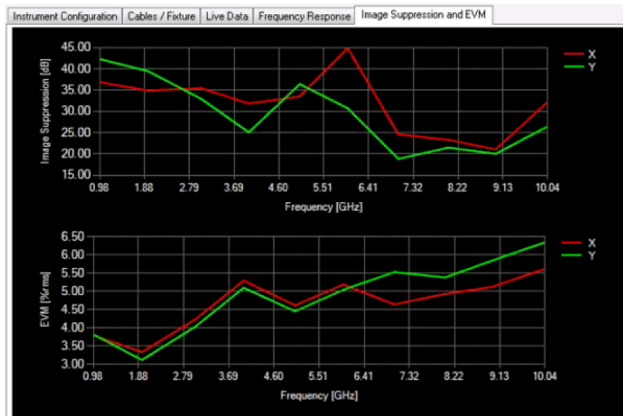
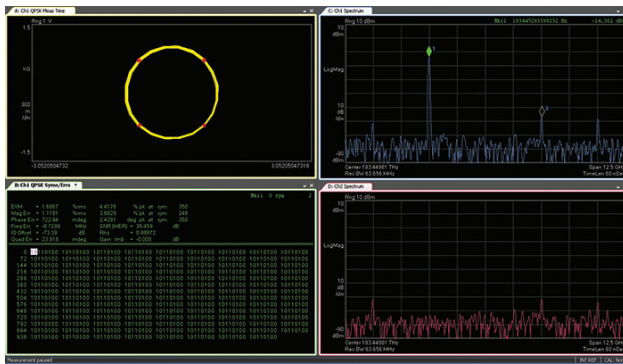
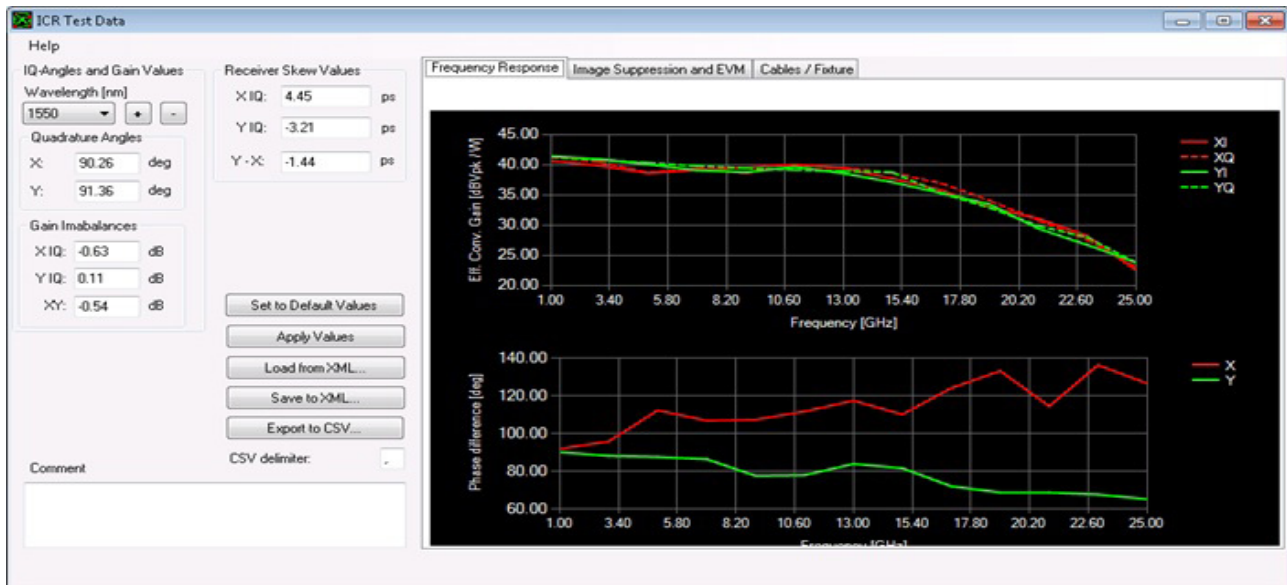

Image suppression is an excellent indication of the presence of potential distortions within the optical receiver. An image suppression in the order > 35 dB indicates high CMRR of well balanced PIN diodes and well de-skewed I-Q channels in the ICR under test.

EVM is an excellent indicator of the overall quality of a complex modulated signal. This concept is applied in that test by creating a beat signal in the ICR and analyzing it in the same way as a complex modulated signal. This emulates a kind of ideal stimulus of the ICR. With this test the EVM can be measured at a single frequency point along the receiver bandwidth of the device under test and within the digitizer bandwidth. This measurement provides additional insight to the device under test, ensuring distortion free measurements at each tested frequency point with good EVM.



Integrated coherent receiver test provides most relevant test parameters as defined by OIF to characterize integrated coherent receiver components. The following test results are provided by the software:

- Relative frequency response $S_{21}(f)$ for each tributary
- Phase difference between X and Y polarization as function of frequency
- Image suppression over frequency
- Error vector magnitude (EVM % rms) over frequency (in addition to OIF) requirements
- Image suppression over frequency (in addition to OIF)

The following parameter are frequency independent impairments measured by the ICR test software:

- Quadrature angles between I and Q for each polarization plane X and Y
- Gain correction values for balanced gain for each polarization plane
- Skew values between each tributary with reference to one channel

Compact - Portable - Affordable



N7786B Polarization synthesizer



The N7786B Polarization synthesizer includes internal SOP monitoring and feedback via a tap coupler to determinately set and hold any chosen states or sequences of polarization. This allows generation of sequences with chosen relative SOP orientation. This is often used for component analysis based on Mueller Matrix or Jones Matrix analysis. The uniquely fast switching supports the new single-sweep spectral PDL measurements with the N7700A software, which eliminates sensitivity to environmental stability and minimizes measurement time. Analysis of these results into transmission spectra of the primary device axes (like TE and TM) is also achieved in this way. The real-time monitoring and logging of output SOP permits accurate calculation including the wavelength dependence of the SOP.

The real-time monitoring and feedback also are used in this instrument to provide stabilized SOP, even with fluctuation and drift of the input SOP.

The output SOP can be defined in following ways:

- Set-and-forget: When the front panel button is pushed, the current SOP is stored and maintained, even if polarization changes occur at the instrument input
- Defined Stokes: The target output SOP can be defined by the user using the Stokes parameters

The Polarization Navigator also has a convenient button to quickly change from a manually adjusted SOP to the corresponding orthogonal state, as can be used to check extinction ratio.

N7786B Polarization synthesizer in coherent receiver test

The N7786B is used adjust the input state of polarization for coherent receiver test with the N4392A. The fast scrambling capability is also used for testing SOP-change tolerance of coherent receivers.

Specifications ¹ N7786B Polarization Synthesizer

Wavelength

Specification wavelength range 1270 to 1375 nm, 1460 to 1620 nm (Opt 400, O/C/L-band)
1460 to 1620 nm (Opt 500, C/L-band)

Operating wavelength range ² 1260 to 1640 nm

Polarization control and stabilization

SOP switching time (non deterministic) < 10 μs

SOP cycling time ⁶ < 25 μs

Remaining SOP error after deterministic SOP setting (typ.) ⁷
< 3° at input SOP movement rate of 1.2 rad/s
< 6.5° at input SOP movement rate of 40 rad/s

Polarization analysis

SOP uncertainty ^{3,4} 1.5°

DOP uncertainty ³ ± 2.0%

DOP uncertainty after user ^{3,5} calibration (typ.) ± 0.5%

Optical power measurement

Relative power uncertainty ³ C/L-Band: ± 0.14 dB (± 0.12 dB typ.), O-band: ± 0.16 dB (± 0.14 dB typ.)

Input power range -38 to +19 dBm

Optical power

Insertion loss < 4.0 dB (< 3.5 dB, typ.)

PDL (typ.) < 0.2 dB (C/L-band), < 0.5 dB (O-band)

Maximum safe input power 20 dBm

1. Ambient temperature change max. ± 0.5 °C since normalization. Specification valid on day of calibration.
2. SOP/DOP measurements are possible outside the specification wavelength range if the user performs a manual calibration.
3. Input power > -20 dBm.
4. DOP > 95%.
5. User calibration requires a source with a 100% DOP.
6. The instrument adaptively finds the polarization controller settings to let the SOP cycle through user-defined polarization states (closed loop operation). After having found these settings, the SOP can cycle through the polarization states in open loop operation.
7. This value is defined to be 5 times the standard deviation of the angular SOP error on the Poincaré sphere. Valid if controller is turned on. Power at instrument input > -10 dBm.

- Real-time bandwidth of up to 63 GHz
- One frame can host four 33 GHz channels and two 63 GHz channels
- The industry's lowest noise and jitter measurement floor

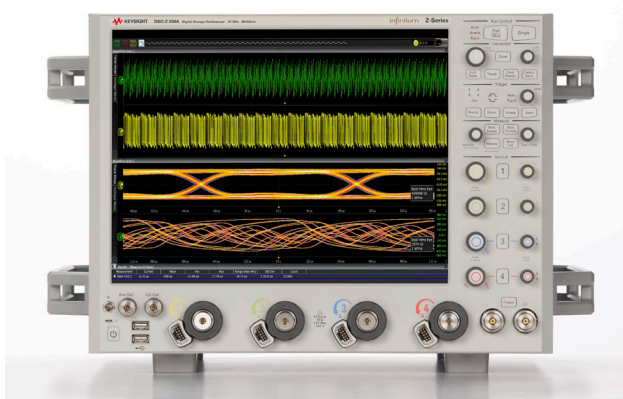

The Infiniium Z-Series oscilloscope

At the extremes of electrical and optical measurements, the right oscilloscope will help you explore the “what” and understand the “why”.

That's the idea behind Z-Series oscilloscopes, our latest step forward in the application of Keysight's microwave expertise to real-time oscilloscopes. With its wide bandwidth, the Z-Series lets you see your fastest signals as they really are. Equip your lab with Z-Series scopes.

Specifications

- 63 GHz analog bandwidth
- 2 channel sample rate: 160 GSa/s
- 4 channel sample rate: 80 GSa/s
- 2 Gpts of memory per channel
- > 20 GHz edge trigger bandwidth
- 30 GHz probing system

Features and benefits

- Up to 33 GHz true analog bandwidth on four channels in a single frame
- Up to 63 GHz true analog bandwidth on four channels in two synchronized frames
- With the N4391A, up to 120 Gbaud symbol rate analysis
- Four times better EVM noise floor than typical QPSK transmitter
- Compact four channels in turn-key solution
- 4 x 80 GSa/s real-time sampling for optimal phase tracking

Next generation optical communications research

Z-Series oscilloscopes are also available in combination with the N4391A optical modulation analyzer as a fully specified turn-key instrument. This compact solution offers the highest bandwidth available on the market and is the most advanced test solution for advanced research on 400G / 1T and beyond transmission.

Even for the lower 20 GHz bandwidth range, this compact and easy-to-use solution is a reference system for 100 G transmission required by R&D labs working at 100 G and beyond.

If you prefer to operate with your own optical receivers but want to benefit from the enormous analysis capability, you can get the N4391A's analysis software as a standalone package.

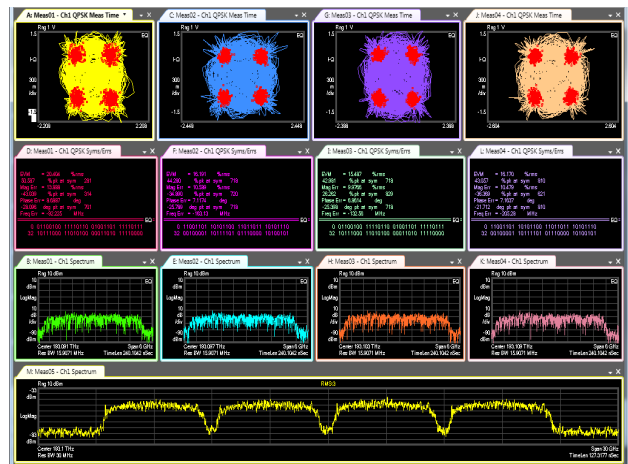

The N4391A based on Z-Series oscilloscope is the tool of choice for 400G multi carrier signal analysis offering up to 126 GHz optical span analysis

Configuring systems with high channel counts

Two oscilloscope ADC channels are required to measure the I and Q vector components of a single-polarization coherent optical channel. Capacity of systems can be further increased by modulating orthogonal polarizations and/or multiple core fibers. For each additional effective carrier, another pair of oscilloscope channels is required. The Keysight Z-Series can be configured with four channels, each with 33 GHz of bandwidth.

For applications requiring wider bandwidths, over 60 GHz can be achieved in two channels. To increase the channel count or to create more than two channels with over 60 GHz of bandwidth, it is possible to gang together multiple oscilloscopes. Through tying together each oscilloscope on a common 10 MHz or 100 MHz reference, the overall system can be synchronized with a channel-to channel timing uncertainty less than 150 fs.



www.keysight.com/find/N7004A



Keysight N7004A Optical-to-electrical Converter

- DC to 33 GHz typical (-3 dBe, electrical)
- Single-mode and multimode inputs
- 50/125 μm , 750 nm -1650 nm (covers main wavelengths: 850 nm, 1310 nm, and 1550 nm)
- Designed for reference receiver testing of industry optical standards or characterizing raw response of an optical transmitter
- Optical measurement features built into the Infiniium baseline software version 05.70 or higher
- Compatible with Infiniium V-Series, 90000 X-Series, Z-Series and discontinued 90000 Q-Series real-time oscilloscopes

Fully integrated optical measurements offered with Infiniium baseline software

The Keysight N7004A optical-to-electrical converter is a high-sensitivity photodetector module designed for direct optical-to-electrical conversion of optical telecom or data com signals into an Infiniium real-time oscilloscope with AutoProbe II interface.

The N7004A is the first fully-integrated optical-to-electrical converter solution for Infiniium real-time oscilloscopes. A full suite of optical measurement software is built into the Infiniium baseline software v 05.70 and is offered at no additional cost. The N7004A comes in a compact form factor that is plugged directly into the AutoProbe II probe interface of the Infiniium oscilloscope.

33 GHz O/E covering up to 28 Gbps optical input

The adapter provides from DC to 33 GHz of electrical bandwidth. When used with an Infiniium V-Series or Z-Series 33 GHz oscilloscope, the N7004A allows users to view optical streams at speeds up to 28 Gbps, making this the ideal solution for characterizing or troubleshooting high-speed optical signals in the system level testing. The N7004A with an Infiniium real-time oscilloscope is the ideal solution for users who want to see the unfiltered response of optical transmissions as well. Each N7004A adapter contains its unique S-parameter correction filter, and this frequency response data is used to flatten the frequency response for more accurate measurement.

Designed for reference receiver testing of industry standard optical measurements or characterizing raw response measurement of an optical transmitter

The input is a 50 μm /125 μm fiber that can be used with 9 μm single-mode fiber or 50 μm multimode fiber at wavelengths from 750 to 1650 nm and has a FC/PC adaptor. The reference receiver measurement is made with a built-in 4th order Bessel Thomson software filter that allows the waveform to be viewed similarly to what an optical receiver in an actual communication system would display. The 4th order Bessel Thomson filter bandwidth is limited to 2/3 of the Brickwall bandwidth of the oscilloscope. For a 33 GHz oscilloscope with the Bessel Thomson filter on, this yields a 22 GHz Bessel Thomson filter, which covers 28 Gbps x 0.75 = 21 GHz.

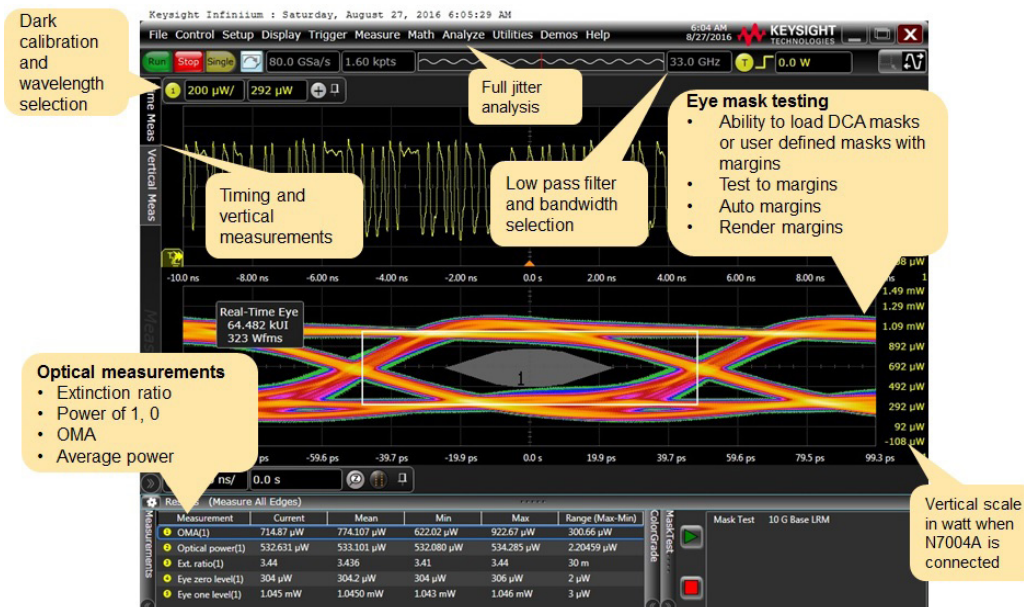

Infiniium V-Series Oscilloscopes (8 to 33 GHz)

NEW

www.keysight.com/find/VSeries

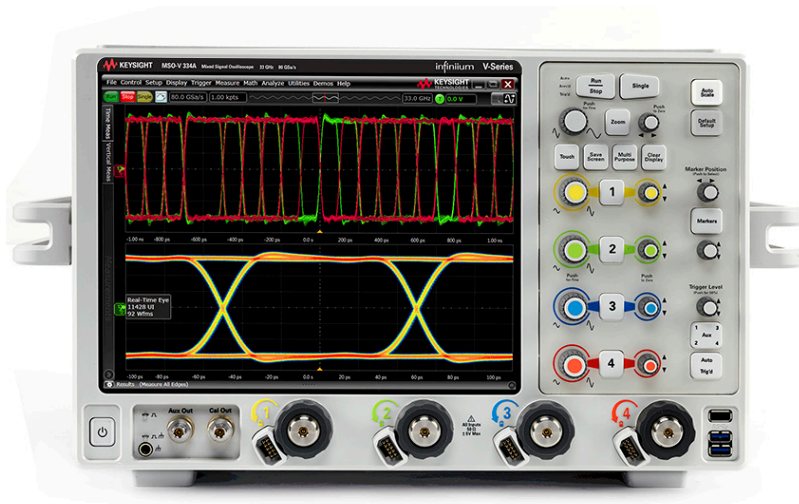

Infiniium V-Series' low-noise front end and the revolutionary voltage termination adapter provide the industry's best signal integrity.

Groundbreaking oscilloscope technology

The Keysight Infiniium V-Series oscilloscopes incorporate innovative technology designed to deliver superior measurements. Whether you are testing multiple high-speed serial lanes or a passive parallel bus, the new 12.5 Gb/s, industry's longest 160-bit hardware serial trigger and world's fastest 20 GSa/s digital channels will provide timely validation and debug. Our oscilloscope's low-noise front end technology, advanced InfiniiMax III/III+ Series probes and revolutionary voltage termination adapter provide up to 33 GHz performance with the industry's best signal integrity. Together with the broadest software solution coverage, the V-Series helps you achieve clarity faster in your design characterization to ensure your product ships on time.

Fastest analysis and enhanced usability

We put the groundbreaking oscilloscope technology in an innovate industrial design frame with a standard 500 GB removable solid state drive and high-powered motherboard for fastest analysis, capacitive 12.1" display for multi-touch usability and USB 3.0 ports for fast data offload speed. Coupled with the next-generation Infiniium user interface, the V-Series makes displaying, analyzing and sharing information much easier. It is the first user interface to take advantage of multiple displays and touch screens. It features up to 8 waveform windows with up to 16 grids in each of them, allowing 128 simultaneous viewing spaces.

DSO models	DSA models	MSO models	Analog bandwidth		Sample rate		Max memory	Bandwidth upgradability
4 analog channels	4 analog channels	4 analog ch + 16 digital ch	2 channels	4 channels	2 channels	4 channels	4 channels	
DSOV334A	DSAV334A	MSOV334A	33 GHz	16 GHz	80 GSa/s	40 GSa/s	2 Gpts	Yes. Each model is upgradable to each higher bandwidth step or the max bandwidth of 33 GHz.
DSOV254A	DSAV254A	MSOV254A	25 GHz	16 GHz	80 GSa/s	40 GSa/s	2 Gpts	
DSOV204A	DSAV204A	MSOV204A	20 GHz	16 GHz	80 GSa/s	40 GSa/s	2 Gpts	
DSOV164A	DSAV164A	MSOV164A	16 GHz	16 GHz	80 GSa/s	40 GSa/s	2 Gpts	
DSOV134A	DSAV134A	MSOV134A	13 GHz	13 GHz	80 GSa/s	40 GSa/s	2 Gpts	
DSOV084A	DSAV084A	MSOV084A	8 GHz	8 GHz	80 GSa/s	40 GSa/s	2 Gpts	



Three amplifiers for different applications

- Direct DAC – optimized for I/Q signal generation with best SFDR & HD
 - SFDR up to -80 dBc (typ.), $f_{out} = 100$ MHz, measured DC to 1 GHz
 - Amplitude ~ 350 mVpp ... 700 mVpp, offset -20 to +20 mV
 - Differential output
- DC amplifier 1 – optimized for serial data /time domain applications
 - Amplitude 500 mVpp to 1.0 Vpp; output voltage window: -1.0 to +3.3 V
 - Trise/fall, 20% to 80% < 60 ps
 - Differential output
- AC amplifier 1 – optimized to generate direct IF/RF signals
 - 50 MHz to 5 GHz bandwidth
 - Single ended, AC coupled output
 - Amplitude: 200 mVpp to 2.0 Vpp

M8190A at a glance

- Precision AWG with two DAC settings
 - 14-bit vertical resolution up to 8 GSa/s sampling rate
 - 12-bit vertical resolution up to 12 GSa/s sampling rate
- Variable sample rate from 125 MSa/s to 8/12 GSa/s
- Spurious-free-dynamic range (SFDR) up to 80 dBc typical
- Harmonic distortion (HD) up to -72 dBc typ.
- Up to 2 GSa arbitrary waveform memory per channel with advanced sequencing
- Analog bandwidth 5 GHz per channel or IQ bandwidth 10 GHz per module
- 3-levels sequencing capabilities
- Digital up-conversion
- Turn-key bundled configuration including chassis and connectivity
- Form-factor: 2 U AXIe module, controlled via external PC or AXIe system controller
- Supported software Keysight Benchlink Waveform Editor, MATLAB, LABVIEW, Keysight Signal Studio (pulse builder and multitone ²), Keysight SystemVue, Keysight wideband waveform center

The M8190A Arbitrary Waveform Generator works with all leading software platforms



High Spectral Efficiency with the Keysight M8190A Arbitrary Waveform Generator

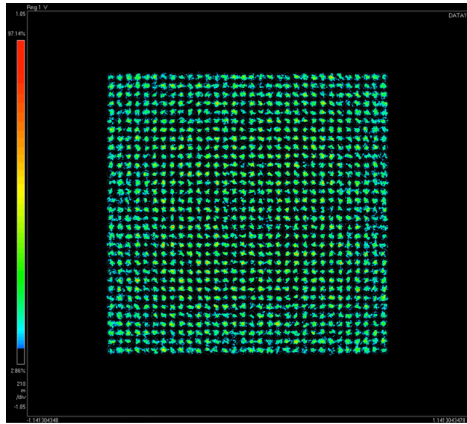

Optical 1024 QAM: 10 bits/Symbol in at 3 GSymbols/sec generated with the high precision M8190A AWG

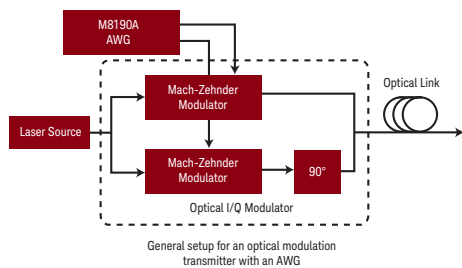

General setup for an optical modulation transmitter with an AWG

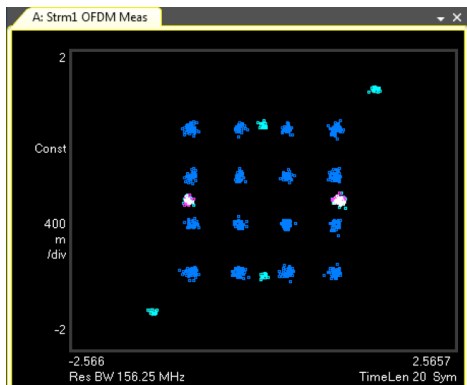

10 Gb/s OFDM Signal with 64 subcarriers generated with the high precision M8190A AWG

The never-ending demand for more data and for higher-speed data can be addressed either due to higher sampling rate/bandwidth or with higher modulation. High order modulations allow cramming more information into the same channel bandwidth but require a very precise and clean signal. With an optical 1024QAM modulation for example it is possible to generate 60 Gbit/s signal, the source is the M8190A a 14 bit arbitrary waveform generator. The signal quality results in up to 20 bit/s/Hz spectral efficiency in dual polarization coherent optical transmission.

Reaching higher spectral efficiency with higher order modulation schemes is one way to serve the broadband hunger by staying with the same infrastructure. Another method would be using a new technology of coding namely CO-OFDM. It stands for Coherent Optical – Orthogonal Frequency Division Multiplexing. This technology is already used for many years in the wireless communication domain and now enters the optical communication world. The main idea behind OFDM is using a numerous orthogonal subcarriers to encode and transmit the data. Each carrier is then complex modulated itself. Either a simple QPSK scheme can be used or higher-order QAM modulations.

Optical OFDM is particularly advantageous in PON networks. With it the bandwidth can be adjusted dynamically by client plus OFDM makes use of cost effective electronic devices instead of costly optical devices in the communication link.



M8195A in a 2-slot AXIe chassis

M8195A at a Glance

The M8195A is an arbitrary waveform generator with a combination of high sample rate, high bandwidth and high channel density

- Sample rate up to 65 GSa/s (on up to 4 channels)
- Analog bandwidth: 20 GHz
- 8 bits vertical resolution
- Up to 16 GSa of waveform memory per AXIe module¹
- 1, 2 or 4 differential channels per 1-slot high AXIe module (number of channels is software upgradeable)
- Multi-module synchronization up to 16 channels per 5-slot AXIe chassis¹
- Advanced 3-level sequencing with external dynamic control
- Load new waveforms on-the-fly without interrupting the playback of the previous one (“memory ping-pong”)
- Amplitude up to 1 Vpp(se) (2 Vpp(diff.))
- Trise/fall 20%/80% < 18 ps (typ)
- Ultra low intrinsic jitter
- Built-in frequency and phase response calibration for clean output signals
- 16-tap FIR filter in hardware for frequency response compensation
- Precise trigger
- Up to 2 markers with 1 sample resolution

Key Applications

As devices and interfaces become faster and more complex, the M8195A AWG gives you the versatility to create the signals you need for digital applications, optical and electrical communication, advanced research, wideband radar and satcom.

- Coherent optical - a single M8195A module can generate 2 independent I/Q baseband signals (dual polarization = 4 channels) at up to 32 Gbaud and beyond
- Multi-level / Multi-channel digital signals - generate NRZ, PAM4, PAM8, DMT, etc. signals at up to 32 Gbaud. Embed/De-embed channels, add Jitter, ISI, noise and other distortions.
- Physics, chemistry and electronics research - generate any mathematically defined arbitrary waveforms, ultra-short yet precise pulses and extremely wideband chirps
- Wideband RF/μW - generate extremely wideband RF signals with an instantaneous bandwidth of DC to 20 GHz for aerospace/defense/communication applications

Go where you have never been able to test before: In speed, in bandwidth and in channel density – explore your possibilities.

The M8195A Arbitrary Waveform Generator works with all leading software platforms

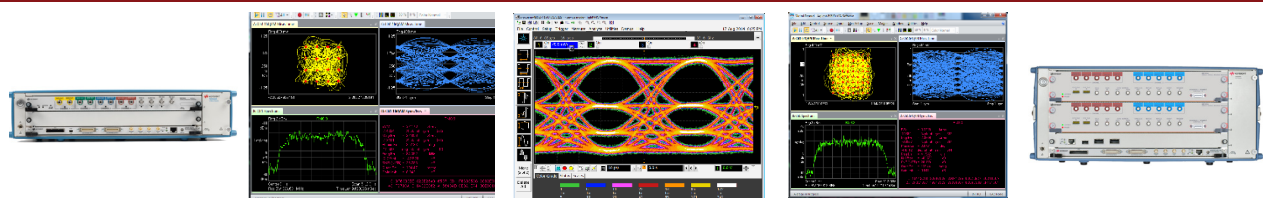

Coherent optical applications

The M8195A supports leading edge research for 100 Gb/s, 400 Gb/s and 1 Tb/s optical transmission systems that require a very wideband electrical stimulus with a variety of complex modulation formats from QPSK to nQAM to OFDM at symbol rates up to 32 Gbaud and beyond.

In order to drive dual-polarization systems, the M8195A has 4 independent, yet precisely synchronized analog output channels in a single module. Since all 4 channels are generated by the same instrument without any external circuitry, precise synchronization below pico-second-range can be achieved and maintained.

The M8195A uses digital pre-distortion techniques for frequency- and phase response compensation of the AWG output and any external circuits is required in order to achieve a clean signal at the device under test.

Distortions generated by cables, amplifiers, etc. can also be compensated by embedding / de-embedding the S-parameters of the respective circuits or by performing an "in-situ" calibration using the Keysight Vector Signal Analysis software.

The M8195A is suited very well to address those challenging requirements.

With up to 4 channels per 1-slot AXIe module, each running at up to 65 GSa/s with 20 GHz of analog bandwidth in combination with advanced frequency response calibration techniques, it can generate clean as well as purposely distorted signals.

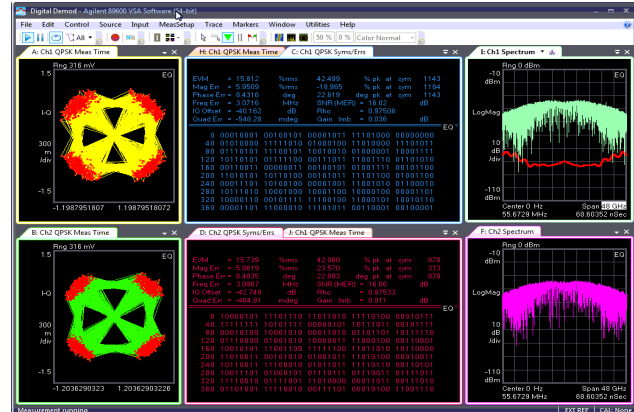

QPSK Signal with added phase noise; emulating a 2 MHz laser line width

An optical modulation generator tool

The Optical Modulation Generator Tool let you generate complex modulated signals as well as sinusoidal signals for calibration and verification purposes. This dedicated graphical user interface allows to setup dual-polarization I/Q modulations at up to 32 Gbaud and beyond.

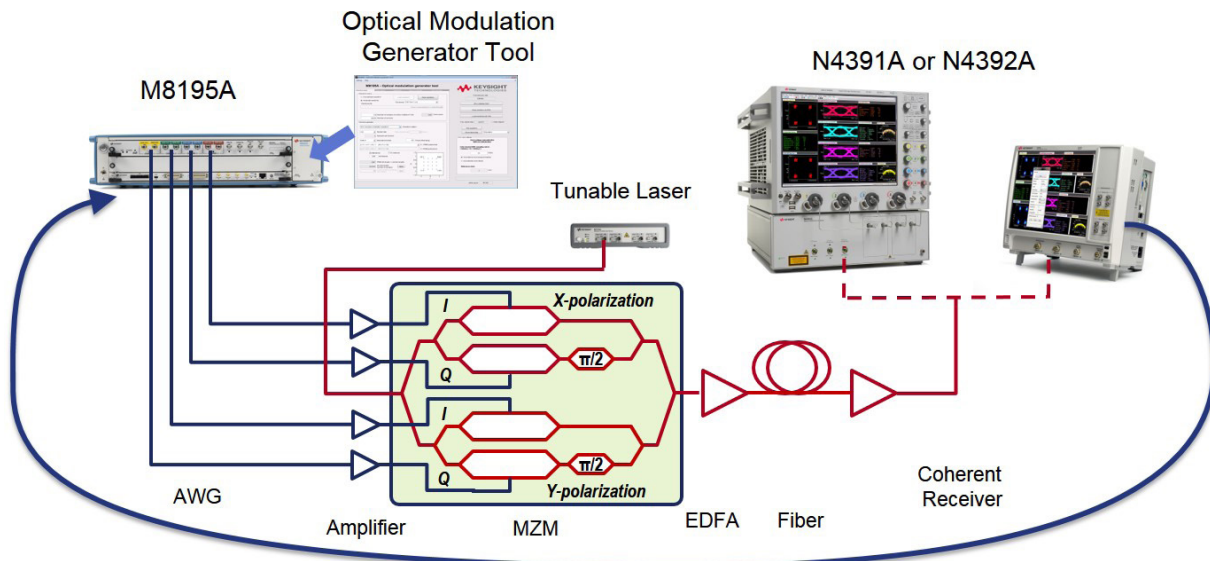



www.keysight.com/find/m8196a



M8196A in a 2-slot AXIe chassis

M8196A at a Glance

- The Keysight Technologies, Inc. M8196A arbitrary waveform generator (AWG) has the highest sample rate and the widest bandwidth in its class with up to four synchronized channels operating simultaneously on one module.
- Sample rate up to 92 GSa/s (on up to 4 ch simultaneously)
- Analog bandwidth: 32 GHz (typical)
- 8 bits vertical resolution
- 512 kSa of waveform memory per channel
- 1, 2, or 4 differential channels per 1-slot AXIe module (number of channels is software upgradeable)
- Amplitude up to 1 Vpp(se) (2 Vpp(diff.)), voltage window -1.0 to +2.5 V
- Trise/fall (20%/80%) < 9 ps (typical)
- Ultra-low intrinsic jitter
- Built-in frequency and phase response calibration for clean output signals

Coherent Optical Applications

200 G, 400 G and 1 Terabit applications demand a new class of generators that provide high speed, precision and flexibility at the same time.

The M8196A is the ideal solution to test different optical systems from discrete components like optical power amplifiers to more complex dual polarization systems like optical modulators or optical receivers.

With up to 4 channels per 1-slot AXIe module, each running at up to 92 GSa/s with 32 GHz of analog bandwidth, it allows dual polarization testing in a small form factor and the generation of complex signals with multiple modulation schemes (PAM-4, PAM-8, QPSK, nQAM) up to an outstanding speed of 64 Gbaud and beyond.

Compensation for distortions generated e. g. by cables and amplifiers can be realized by embedding/de-embedding the S-parameters of the respective circuits or by performing an in-situ calibration using the Keysight Technologies vector signal analysis software.

Combined with the 81195A optical modulation generator software, the M8196A makes it easy to generate optical impairments (e.g. PMD) for stressing the optical receiver over multiple test scenarios.

Multi-Level/Multi-Channel Digital Signals

The M8196A is also ideally suited to address multi-level/multi-channel interfaces using any standard or custom data format, for example high-speed backplane connections using PAM-4 or PAM-8 format, as well as technologies in the mobile application space.

The flexibility of the waveform generation at its highest speeds, combined with excellent intrinsic jitter performance makes the M8196A a truly future-proof instrument.

At data rates of multiple Gb/s, the effect of cables, board traces, and connectors etc. has to be taken into account in order to generate the desired signal at the test point of the device under test. The M8196A incorporates digital pre-distortion techniques for frequency- and phase-response compensation of the AWG output and any external circuit to generate the desired signal at the device under test. Channels can be embedded/de-embedded if the S-parameters of the respective circuits are provided.

In conjunction with the 81195A optical modulation generator software various kinds of distortions can be added to the signal.

With its high channel density the M8196A is well-suited to affordably and precisely stimulate multi-lane high-speed interfaces.

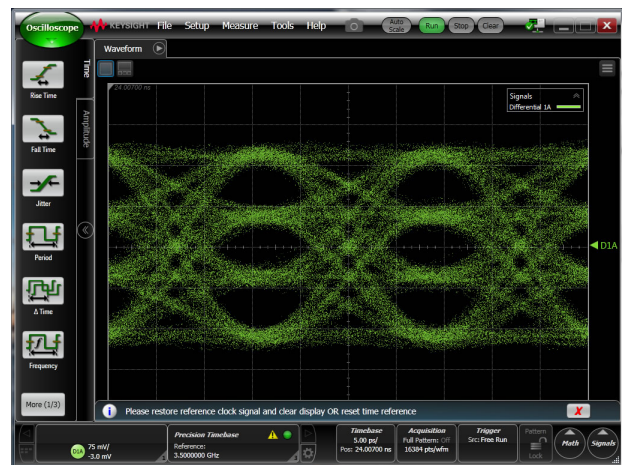

PAM-4 signal at 56 Gbaud

- Data rates up to 8.5/ 16 Gb/s for pattern generator and error detector. Extension to 32 Gb/s possible with M8061A multiplexer
- 1 to 4 16 Gb/s BERT channels in a 5-slot AXIe chassis
- Integrated and calibrated jitter injections: RJ, PJ1, PJ2, SJ, BUJ, clk/2, SSC, sinusoidal interference
- 8- tap de-emphasis (positive and negative) up to 20 dB
- Adjustable and integrated ISI (Intersymbol Interference)
- Interactive link training for PCI Express and USB 3.1
- Built-in clock data recovery and equalization

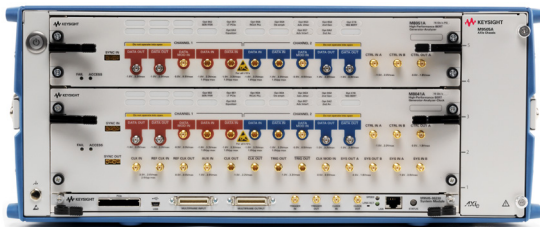

J-BERT M8020A high-performance BERT with 4 channels

The high-performance Keysight J-BERT M8020A enables fast, accurate receiver characterization of single- and multi-lane devices running up to 16 or 32 Gb/s.

With today's highest level of integration, the M8020A streamlines your test setup. In addition, automated in situ calibration of signal conditions ensures accurate and repeatable measurements. And, through interactive link training, it can behave like your DUT's link partner. All in all, the J-BERT M8020A will accelerate insight into your design.

Target applications

R&D and test engineers who characterize, verify compliance of chips, devices, boards and systems with serial I/O ports up to 16 Gb/s and 32 Gb/s. The M8020A can be used to test popular serial bus standards, such as: PCI Express®, USB, MIPI M-PHY, SATA/SAS, DisplayPort, SD UHS-II, Fibre Channel, front-side and memory buses, backplanes, repeaters, active optical cables, Thunderbolt, 10 GbE, 100GbE (optical and electrical), SFP+, CFP2/4 transceivers, CEI.

Specifications

For operating range 32 Gb/s: see M8061A and M8062A
For operation up to 16 Gb/s: M8041A and M8151A

Pattern

- PRBS: $2^n - 1$, $n = 7, 10, 11, 15, 23, 23p, 31$
- Memory: 2 Gbit per channel
- Sequencer: 3 counted loop levels, 1 infinite loop
- Interactive link training for PCIe and USB 3.1
- 10G-KR TX equalization

Pattern generator

- Operating range: 150 MHz to 8.5 GHz (option G08 or C08), 150 MHz to 16.2 GHz (option G16 or C16). For extension to 32.0 Gb/s: use M8061A in addition
- Data outputs: 1 or 4 for 16 Gb/s (option OG2 for second channel per M8041/51A module)
- Output amplitude: 50 mV to 1.2 Vpp (single ended)
- Transition time: 12 ps typical (20-80%)
- De-emphasis: 8 taps positive/ negative (option OG4)
- Intrinsic jitter: 8 ps pp typical
- Connectors: 3.5 mm (f)
- Supplementary outputs: trigger out, clock out, control out, system out

Jitter tolerance test

- Calibrated jitter sources: multi-UI low-frequency jitter up to 5 MHz, high-frequency jitter up to 1 UI @ 500 MHz (RJ, PJ1, PJ2, BUJ, sRJ), clk/2 ± 20 ps
- SSC: ± 5000 ppm
- ISI: adjustable loss up to 25 dB @ 16 GHz. Additionally eight ISI traces (see M8048A)
- Interference: built-in common-mode up to 400 mV and differential-mode up to 30% of output amplitude
- Automated jitter tolerance test

Analyzer

- Data inputs: 1 to 4 (option OA2 for second channel per M8041/51A module)
- Clock recovery: built in, adjustable loop bandwidth up to 20 MHz
- Sensitivity: 50 mV
- CTLE: yes
- Connectors: 3.5 mm (f)

Ordering

J-BERT in 5 –slot AXIe chassis w/ emb. controller	M8020A-BU1
J-BERT in 5 –slot AXIe chassis	M8020A-BU2
16 Gb/s BERT 2 ch with clock, 3–slot AXIe module	M8041A ¹
16 Gb/s BERT 2 ch, 2–slot AXIe module	M8051A
32 Gb/s Front-end for J-BERT	M8061A/2A
System software for M8000 Series	M8070A

1. available options for M8041A: 8.5/16Gb/s, generator-only, 2nd channel generator/analyzer, de-emphasis, jitter sources, interference sources, reference clock multiplier, SER/FER analysis, link training, CTLE, ISI

- Expands data rate of J-BERT M8020A up to 32.4 Gb/s
- Fully unique integrated capabilities for higher-data-rate testing
 - Integrated adjustable inter symbol interference (ISI) helps engineers quickly test over a large range of channel loss without moving cables
 - Integrated analyzer equalization ensures accurate BER measurements by opening eyes in the looped-back channel
- Integrated 8-tap de-emphasis allows engineers to emulate transmitter operation and de-embed test setups
- Improved efficiency and accuracy for 100G and beyond testing
- Interactive TxEQ training for 25GBASE-KR and 100GBASE-KR4
- Control from J-BERT M8020A high-performance BERT

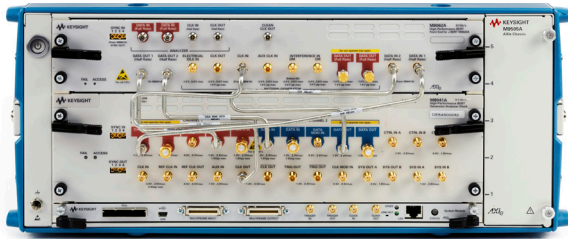

The M8062A multiplexer in a 32 Gb/s BERT setup with J-BERT M8020A

The M8062A 32 Gb/s module expands the J-BERT M8020A high-performance BERT with versatile generator and analyzer functionality at data rates up to 32.4 Gb/s. The newly integrated capabilities streamline testing for R&D and test engineers who need to characterize devices and systems for next-generation data-center and long-haul-communication applications. Fully integrated capabilities like inter symbol interference generation, clock data recovery and analyzer equalization greatly improve device characterization and compliance testing and significantly simplifies test setups. The M8062A is a 2-slot AXIe module that can be controlled via USB through the integrated user interface of the J-BERT M8020A or through remote programming commands to allow test automation.

Target applications

R&D and test engineers who characterize, verify compliance of chips, devices, boards and systems with serial I/O ports up to 32 Gb/s. Typical receiver test applications include:

- Optical transceivers such as 100GBASE-LR4, -SR4 and -ER4, 32G Fibre Channel
- SERDES and chip-to-chip interfaces, such as OIF CEI
- Backplanes, cables, such as 100GBASE-KR4, -CR4
- SAS-4 receiver testing
- Thunderbolt 20G and active optical cables

Get Accurate Results Based on M8062A's Excellent Output Performance

The eye quality of the pattern generator output is critical when characterizing many pass through devices such as TOSAs. The low intrinsic random jitter assures that you will be measuring the true performance of the device under test itself. Fast transition times preserve the eye opening at the highest data rates, maintaining margins for repeatable BER measurements.

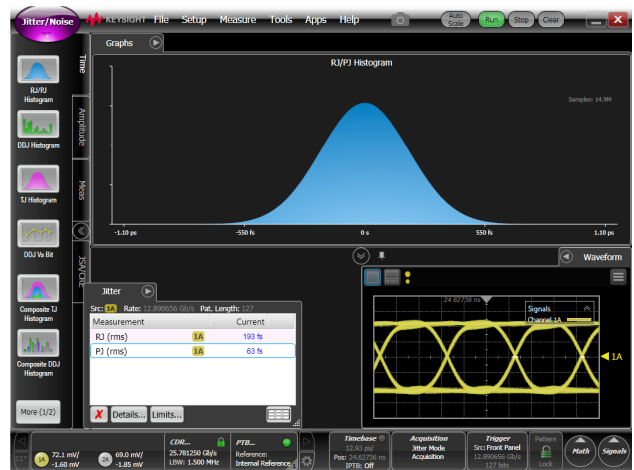

Intrinsic RJ < 200 fs

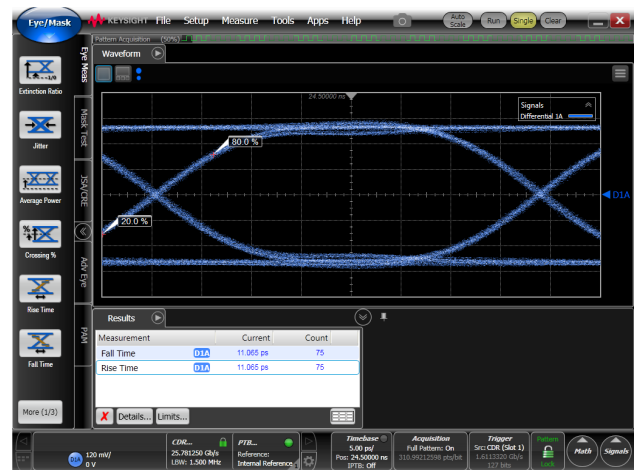

Output eye showing rise time < 12 ps

M8040A 64 Gbaud High-Performance BERT

NEW

www.keysight.com/find/m8040a

- Data rates from 2 to 32 and 64 Gbaud for pattern generator and analyzer
- PAM-4 and NRZ selectable from user interface
- Built-in de-emphasis with 4 taps
- Integrated and calibrated jitter injection: RJ, PJ1, PJ2, SJ, BUJ, and clk/2 jitter
- Two pattern generator channels per module to emulate aggressor lane
- True PAM-4 error detection in real-time for low BER



M8040A 64 Gbaud High-performance BERT

Master your 400G design

The Keysight M8040A is a highly integrated BERT for physical layer characterization and compliance testing. With support for PAM-4 and NRZ signals and data rates up to 64 Gbaud (corresponds to 128 Gbit/s) it covers all flavors of 200 and 400 GbE standards.

The M8040A BERT offers true error analysis and provides repeatable and accurate results optimizing the performance margins of your 400GbE devices.

Target applications

The M8040A is designed for R&D and test engineers who characterize chips, devices, transceiver modules and sub-components, boards and systems with serial I/O ports operating with symbol rates up to 32 Gbaud and 64 Gbaud in the data center and communications industries. The M8040A can be used for receiver (input) testing for many popular interconnect standards, such as:

- IEEE 802.3bs 400 and 200 Gigabit Ethernet
- IEEE 802.3bj, IEEE802.3cd
- OIF CEI - 56G (NRZ and PAM-4 versions)
- 64G/112G Fibre Channel, Infiniband-HDR
- Proprietary interfaces for chip-to-chip, chip-to-module, backplanes, repeaters, and active optical cables, operating up to 64 Gbaud.

Key specifications for M8040A

Pattern generator module M8045A with remote head M8057A	
Operating range	2.025 to 32.4 Gbaud (M8045A-G32), 2.025 to 58 Gbaud (opt. G64) with over-programming up to 64.8 Gbaud
Data formats	NRZ and PAM-4 (option -OP3 and -OP6)
Data outputs	1 or 2 per module
Output amplitude	50 mV to 0.9 Vpp (single ended) for symbol rates < 32.4 Gbaud, 50 mV to 0.6 Vpp (single ended) for symbol rates < 58Gbaud
Transition time	9 ps typical for symbol rates > 32.4 GBd, 11 ps typical (20-80%) for < 32.4 GBd
De-emphasis	4 taps positive/ negative (option -OG4)
Intrinsic jitter	7 mUI rms typical for symbol rates between 22 and 32.4 Gbaud
Connectors	1.85 mm (f)
Supplementary outputs	trigger out, clock out, control out, system out
Pattern	
PRBS	2 ⁿ -1, n = 7,10, 11, 15, 23, 23p, 31, 33, 35, 39, 45, 49, 51
QPRBS	QPRBS13-CEI, QPRBS31-CEI, QPRBS13, PRBS13Q, PRBS31Q, SSPRQ
Memory	2 Gbit per channel
Sequencer	3 counted loop levels, 1 infinite loop
Jitter tolerance test	
Calibrated jitter sources	multi-UI low-frequency jitter up to 10 MHz, high-frequency jitter up to 1 UI @ 500 MHz (RJ, PJ1,PJ2, BUJ, sRJ), clk/2 (M8045A-OG3)
SSC	±5000 ppm
Level interference	adjustable RI and SI injection via M8195/6A and external couplers
Analyzer module M8046A	
Operating range	2.025 Gbaud to 32.4 Gbaud for M8046A-A32
Data inputs	1 per module
Data formats	NRZ and PAM-4 (option -OP3)
Sensitivity	70 mV per eye
Clock recovery	with N1076A for NRZ and PAM-4

Fast, compact, and affordable BER testing

Testing 16x Fibre Channel (16GFC) transceivers, Infiniband FDR, Infiniband EDR, 100 G Ethernet etc, requires equipment capable of operating up to at least 25 Gb/s, with accurate characterization to strict tolerances. Until now, these systems have been extremely expensive. This often results in multiple designers needing to share the one serial BERT in the lab, delaying their characterization and development schedule.

The Keysight Technologies N4960A serial BERT 32 and 17 Gb/s is an affordable alternative for R&D working at data rates up to 32 Gb/s.

The solution is compact, allowing it to be easily transported throughout the lab and manufacturing. But with its low price, a fraction of competing stressed BERTs, you can afford to put one on each bench.



16 x Fibre Channel (16 GFC) transceiver testing

Compact architecture

The N4960A serial BERT controller is a platform that forms the basis of the stressed serial BERT. The N4960A serial BERT controller adds the precision timing and control required for the remote pattern generator and error detector heads.

The concept of remote heads, first introduced in the N4965A multi-channel BERT, puts the pattern generation and error detection near the device under test, eliminating long cables which degrade the signal. This is especially important at higher data rates.



N4980A JTOL measurement window

Affordability without compromise

The N4951A/B pattern generator and N4952A error detector remote heads are available in two data rate ranges covering either 4 to 17 Gb/s or 5 to 32 Gb/s with no gaps or missing data rates. They generate and test full rate patterns directly without the need for external multiplexers and delay matching often used in other modular BERT systems.

The signal fidelity in the eye is outstanding, owing to the use of custom-designed and built output amplifiers. Output parameters of amplitude, offset, and termination voltage are user settable.

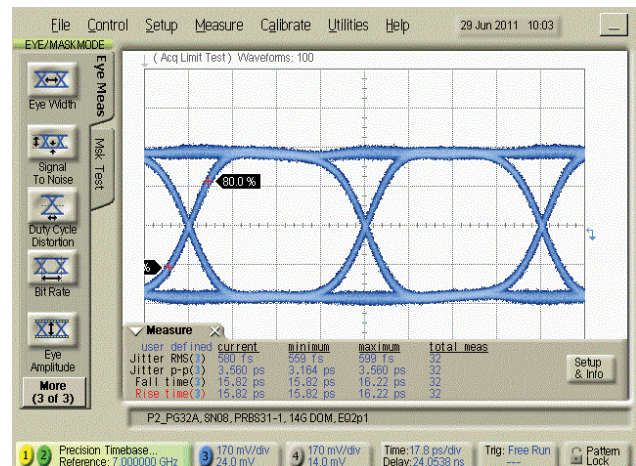

Typical eye at 14 Gb/s

Accurate, repeatable jitter tolerance

The N4960A serial BERT controller contains an accurately calibrated sinusoidal jitter source capable of high deviation at low frequencies, and lower deviation at frequencies up through 200 MHz. A second sinusoidal jitter source, plus random jitter source and spread spectrum clocking can be added with option -CJ1.

Integrated analysis software

Support for both models of the N4960A is included in the N4980A multi-instrument BERT software. The software provides an intuitive user interface. It also provides single or multi-channel BER measurement capability with an unlimited number of channels. Setup is so easy that you'll be testing in seconds.

The optional JTOL measurement package in the N4980A multi-instrument BERT software (Signal Integrity Studio) performs all the set-up and control for single or multi-lane JTOL, and with an intuitive "point and click" template editor.

N4960A Controller Specifications

Standalone clock source and/or Serial BERT controller

Clock output configuration:

Jitter (stressed), Delay, and Divided outputs available. Clock generator Jitter and Delay outputs are shared with Pattern Generator (PG) and Error Detector (ED) heads respectively. The PG/ED data rate is double the frequency of the clock outputs.

1.5 to 16 GHz (1.5 to 8.5 GHz when N4951A-P17, N4951B-H17/D17 or N4952A-E17 is attached)

Jitter (stressed), Delay, and Divided

Differential

300 mV to 1.7 V pp, single ended

0 to $\pm 1,000$ UI

$\div 1, 2, 3, \dots, 99,999,999$ integer divider

Jitter clock injection (with no pattern generator heads attached)

Sinusoidal SJ1, SJ2 1 – 200 MHz, up to 1UI

Random RJ Up to 25 mUI

Periodic PJ 1 to 17 MHz, up to 100 UI (to 62.5 kHz)

SJ2, RJ requires Option -CJ1. The amplitude of any stress appearing on the front panel jitter clock output will be 1/2 of the value appearing in the N4951A/B pattern generator head. Changing stress amplitudes on the front panel jitter clock output will also change the level appearing on the pattern generator output

Spread spectrum clock (Option -CJ1) 1 Hz to 50 kHz, 0 to 1.0 %, Triangle, down spread, center spread, or up spread.

Keysight N4951B



Keysight N4952A



Pattern generator head specifications	
Data rate range	4 to 17 Gb/s (Options P17/H17/D17) 5 to 32 Gb/s (Options P32/H32/D32)
Pattern selection	
– PRBS	$2^n - 1$, $n = 7, 9, 10, 11, 15, 23, 29, 31, 33, 35, 39, 41, 45, 47, 49, 51$ K28.3, K28.5, K28.7, CJPAT, CJTPAT, CRPAT, JSPAT, JTSPAT
– Clock	$\div 2, \div 4, \div 8, \dots, \div 64$
– User	1 bit to 8 Mb programmable using N4980A Multi-instrument Software
Data output configuration	Differential. May be operated single end with unused output terminated into 50 Ω AC Coupled with internal bias tee
Data output amplitude	Adjustable up to 1V pp single ended (option P17/32), 1.5V (option D17/D32), 3V (option H17/H32)
Data output amplitude	16 ps typical (Options P17/P32/ D17/ D32), 12 ps typical (Options H17/H32)
De-emphasis	Option D17/D32 has integrated 5-tap de-emphasis
Jitter injection	
– Sinusoidal SJ1, SJ2	1 to 150 MHz, up to 0.8 UI
– Random RJ	Up to 24 mUI
– Periodic PJ	1 to 17 MHz, up to 100UI (to 62.5 kHz) SJ2, RJ requires N4960A controller with Option –CJ1
Error detector head specifications	
Data rate range	4 to 17 Gb/s (Option E17) 5 to 32 Gb/s (Option E32)
Pattern selection	
– PRBS	$2^n - 1$, $n = 7, 9, 10, 11, 15, 23, 29, 31, 33, 35, 39, 41, 45, 47, 49, 51$ K28.3, K28.5, K28.7, CJPAT, CJTPAT, CRPAT, JSPAT, JTSPAT
– Clock	$\div 2, \div 4, \div 8, \dots, \div 64$
– User	1 bit to 8 Mb programmable using N4980A Multi-instrument software
Data output configuration	Differential. May be operated single end with unused output terminated into 50 Ω .AC coupled with internal bias tee
Data input range	100 mV to 1 V (p-p) single ended
Data delay range	± 2000 UI
Measurements	Instantaneous and accumulated BER, Error count, Errored 1's and 0's, Data loss, Sync loss. Multi-channel BER, bathtub scan, jitter tolerance testing (with N4980A software)
N4960A controller options	
N4960A-CJO	Standard jitter injection (single tone sinusoidal)
N4960A-CJ1	Expanded jitter injection (two tone sinusoidal, random and SSC)

Remote head options:

- N4951A-P17 pattern generator 17 Gb/s
- N4951A-P32 pattern generator 32 Gb/s
- N4951B-H17 pattern generator high amplitude 17 Gb/s
- N4951B-H32 pattern generator high amplitude 32 Gb/s
- N4951B-D17 pattern generator with 5-tap de-emphasis 17 Gb/s
- N4951B-D32 pattern generator with 5-tap de-emphasis 32 Gb/s
- N4952A-E17 error detector 17 Gb/s
- N4952A-E32 error detector 32 Gb/s



The Keysight N4980A multi-instrument BERT software provides the ability to control multiple instruments through a rich Windows-based graphical user interface (GUI). Bit error rate measurements are simple to set up with the intuitive control screens. The software is ideal for setting up and performing parallel BER measurements and jitter tolerance testing (N4980A-JTS) in multi-lane and SERDES devices. You can also create your own patterns using the powerful editing tools built into the pattern editor to meet your unique requirements.

Key features & Specifications

- Software is Windows-based controlling equipment through USB or GPIB
- Simple and fast setup
- Full instrument remote control
- Test single and multi-lane BER with active aggressor signals
- Monitor instantaneous BER over time or measure BER over a specific period
- Fast and efficient parallel jitter tolerance testing (N4980A-JTS)
- View BER-measured BERT scan (often called bathtub curve, a horizontal slice through eye)
- Intuitive pattern editor
- De-emphasis tap weight calculator for easy calculation of required tap settings and programming to supported de-emphasis pattern generators

Applications

- Serial data receiver characterization
- Parallel BER measurements
- N4980A-JTS for jitter tolerance testing
- Optical transceiver/transponder characterization

The base software is available free of charge (registration required for download). The N4980A-JTS jitter tolerance measurement package is an option enabled by a software key.



www.keysight.com/find/plts

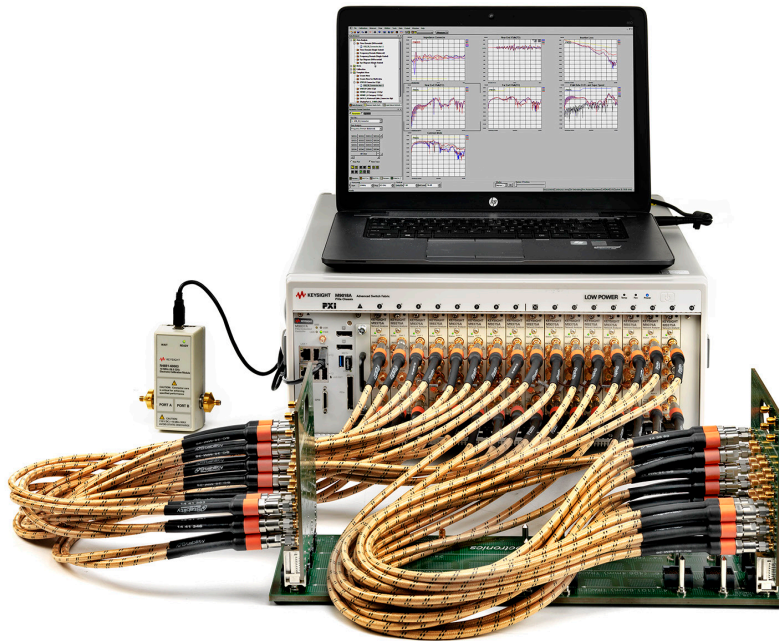

The Keysight Digital Interconnect Test System (www.keysight.com/find/diref) is a 32-port PXI-based vector network analyzer optimized for production test of high speed cables.

Breakthrough Manufacturing Test Capability

The new Physical Layer Test System (PLTS) 2017 has significant breakthrough capabilities with regards to manufacturing test of high-speed interconnects, such as cables, backplanes, PCBs and connectors. Many signal integrity laboratories around the world have benefitted from the power of PLTS in the R&D prototype test phase.

PLTS 2017 now has a full complement of SCPI (Standard Commands for Programmable Instruments) commands that enable automated programming of test sequences that are ideal for high-volume production testing. Over 200 SCPI commands provide a solid base upon which efficient automated testing can take place on the manufacturing floor. This software capability coupled with the new 32-channel PXI-based vector network analyzer (VNA) produces the fastest VNA measurements in the world. A fully crossbar calibrated 32-port S-parameter measurements now takes only 10 to 15 seconds depending on IFBW settings.

Another significant enhancement to PLTS 2017 is the addition of PAM-4 eye diagram testing. Higher data rates such as the new 100G and 400G Ethernet infrastructures require much more efficient modulation techniques and PAM-4 fulfills this requirement. Having leading edge test equipment in the signal integrity lab that can measure PAM-4 provides the competitive edge now required.

A Standard for Signal Integrity Analysis

The last major enhancement to PLTS 2017 has to do with a very progressive figure of merit called "Channel Operating Margin" or COM. Many new high-speed standards depend upon complex communication protocols, such as the emerging 100 Gigabit Ethernet interface (100GbE). A recent version of this protocol standard -- IEEE 802.3bj-2014 -- added a 4-lane X 25Gbps physical specification for backplanes, connectors, and twinax copper cables. The emergence of advanced, high-data rate channels introduced the problem of how Tx/Rx chip IP developers and system designers could concurrently and independently proceed with their product implementations. A new facet to standardization was needed, to define how analysis of these channels could be pursued -- the Channel Operating Margin methodology was subsequently defined. This is a complex MATLAB script implemented within PLTS that is user definable for flexibility. Again, PLTS successfully takes a very complex test methodology and implements a user friendly interface to simplify testing for the signal integrity engineer.

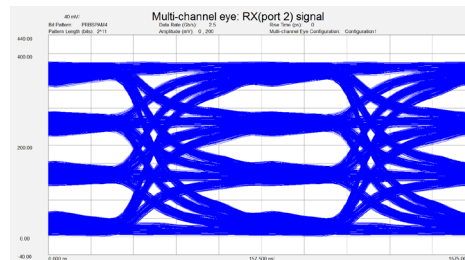

Pulse Amplitude Modulation (PAM-4) is the next generation modulation technique that will meet the data density requirements for 56Gigabits per second data transmission channels

NEW

www.keysight.com/find/n4917b

Repeatable Optical Receiver Stress Test for 100GBASE-SR4/LR4/ER4

In recent years, transmission speeds in gigabit ethernet have continuously increased from 10 Gb/s to 40 Gb/s and are now approaching the 100 Gb/s speed class. 10 Gb/s Ethernet was designed based on a 10.3125 Gb/s line rate on one single-mode fiber per direction. The 40 Gb/s Ethernet speed class changed this to an architecture using the same 10.3125 Gb/s line rate but using 4 optical wavelengths in the O-Band on one single-mode fiber per direction. This increased the transmission capacity by a factor of 4, without a need to make changes to the speed of the electrical components. In the last few years the 100 Gb/s speed class has been established, leveraging the 40 Gb/s optical architecture and also increasing the electrical line rate from 10.3125 Gb/s to 25.78125 Gb/s.

The conformance test specification for 100 Gb/s transmission speed class is defined in the IEEE 802.3 standard, clause 88 for 100 Gb/s Ethernet (GbE) for long reach (LR4), extended reach (ER4), and clause 95 for short reach (SR4).

The N4917B optical receiver stress test solution provides an **automated** stressed receiver sensitivity test in accordance with the 100GBASE-LR4, -ER4, and -SR4 test specification. In order to do this kind of test, several test instruments such as a bit error ratio tester, digital sampling oscilloscope, optical reference transmitter and tunable laser source are required to operate together to achieve a compliant, repeatable optical stressed eye.

The N4917B solution provides:

Automated calibration of the optical stressed eye according to IEEE 802.3 clause 88 and clause 95

- Calibration of ER, VECP, J2, J9, OMA parameters for clause 88
- Calibration of ER, SEC, J2, J4, OMA parameters for clause 95
- Repeatable results
- Adjustable target values ER, VECP, SEC, J2, J4, J9, OMA
- Jitter tolerance compliance and margin test
- Electrical loop back or optional DUT control interface for full automated JTOL test
- Remote control of all the test instrumentation
- Includes an optical reference transmitter for 25.78125 Gb/s

N4917B Detailed Test Setup for 100GBASE-LR4/ER4

The core instrument of the optical stressed eye test setup is the J-BERT M8020A High-Performance BERT system that provides an electrical signal with all the required impairments (random and sinusoidal timing jitter, ISI and sinusoidal amplitude interference) at the data signal output, using a combination of its built-in stress sources plus an external generator. This electrical signal is fed into the 81490A electrical-optical converter to modulate the laser and create the stressed optical signal. A 8160xA tunable laser is used to set the wavelength for each of the 4 lanes in turn. The optical output of the 81490A is then attenuated to get to the required optical power level at the input of the receiver under test.

Prior to testing the receiver, the optical signal for each wavelength is calibrated using the 86100D Infiniium DCA-X Wide-Bandwidth Oscilloscope with 86105D optical module which is set up as a reference receiver. All of the equipment is under control of the N4917B software, which takes care of the various equipment settings and performs an iterative adjustment of the BERT stressess until the optical signal measured on the DCA-X meets the required stressed eye parameters (ER, VECP, J2, J9).

After the calibration step, each lane of the DUT should be tested in turn, with valid signals present on the other lanes. Exact connection details and setup depend on the type of device being tested, but a typical example for a transceiver test is shown below. In this example an optical de-multiplexer is used to bring out the 4 lanes on 4 individual fibers. Attenuators in each lane are used to set the relative optical modulation amplitude (OMA) with respect to the lane under test. The calibrated stressed eye signal is connected to the lane under test at the optical multiplexer which combines all 4 lanes onto one fiber. BER measurement during the Jitter Tolerance test sweep can either be read from the device under test or optionally looped back to the BERT for fully automated JTOL testing.

N4917B Detailed Test Setup for 100GBASE-SR4

In principal the SR4 setup is similar to the described setup above with the following differences:

- The tunable laser source is replaced by the already built-in 850 nm laser source in the 81490A-E10 optical reference transmitter.
- The required clock recovery unit at the input of the optical reference receiver is provided by the N1077A-SMS and N1077A-232.

At the end of the calibration a mask test is performed to verify the stressed eye for compliance to the required stressed receiver eye mask definition.



N4917B User Interface

The N4917B optical receiver stress test solution runs on the same computer as the M8070A System Software for J-BERT M8020A. The N4917B controls all of the instruments via USB, LAN or GPIB connections.

The main screen of the N4917B software, the Stressed Eye tab, provides setting of the parameters required for the calibration of the stressed eye, runs the stressed eye calibration and displays the results for the calibrated stressed eye components.

The two remaining tabs – Jitter Conformance and Jitter Performance are used when testing the device for compliance or margin testing.

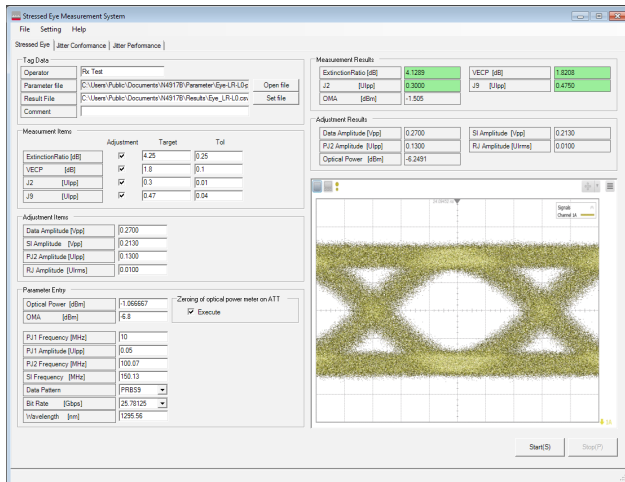

The figure above shows the stressed eye screen to setup the desired calibration parameters: ER, VECP, J2 and J9 jitter. In addition various other parameters can be modified for individual setups.

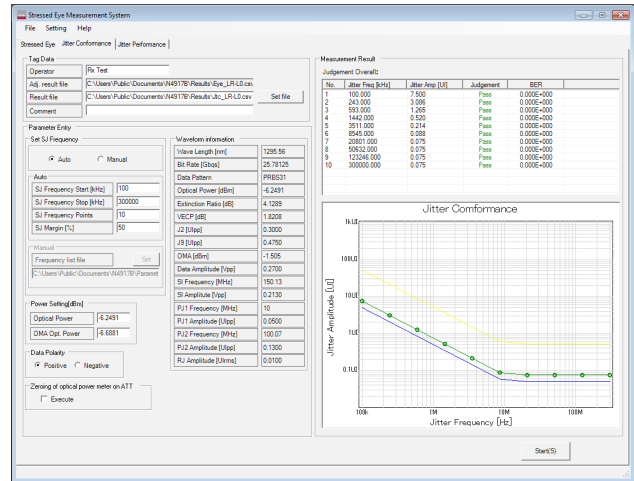

Jitter conformance test.

N4917B Jitter Conformance And Performance Tests

Depending on the test setup and DUT capabilities it is also possible to run fully automated jitter tolerance measurements using built-in JTOL measurement within the M8070A System Software.

This test is used when either

- The DUT can be put into loopback mode and a signal from the lane under test is fed back to the BERT, or
- The DUT can be controlled directly from the M8070A software using the DUT Control Interface (license required) to read the BER directly from the DUT internal error checker counters.

The M8070A JTOL measurement can also be run as a compliance test with/without margin or a tolerance test to find the limits of the DUT. It has several additional features such as a choice of search algorithm, user definable BER depth, etc.

N4917B Jitter Conformance And Performance Tests

The stressed receiver sensitivity test explained in the IEEE 802.3 standard requires a sweep of sinusoidal jitter on top of the previously calibrated jitter and the interference stress and at a specific OMA level. The DUT must meet or exceed a BER of 1×10^{-12} for LR4/ER4 or BER of 5×10^{-5} for SR4 under these conditions. The N4917B software provides two jitter measurements. The Jitter conformance tests per the compliance level in the standard and the optional user selectable margin can be applied to test at a slightly higher level than the standard requires. The Jitter Performance test allows the user to find the limits of the jitter tolerance test for more detailed margin testing.

Results of the jitter measurements are shown numerically and graphically. In example below, the blue line is the jitter tolerance compliance limit from the IEEE 802.3 standard. The green dots represent actual test data, at the user selectable margin. The yellow line indicates the maximum margin limits of the jitter tolerance test.

In these tests the stress level is automatically setup by the N4917B software, using a previously run calibration and the user enters the BER results manually. This test is most appropriate when the BER can be visually read from the DUT user interface.

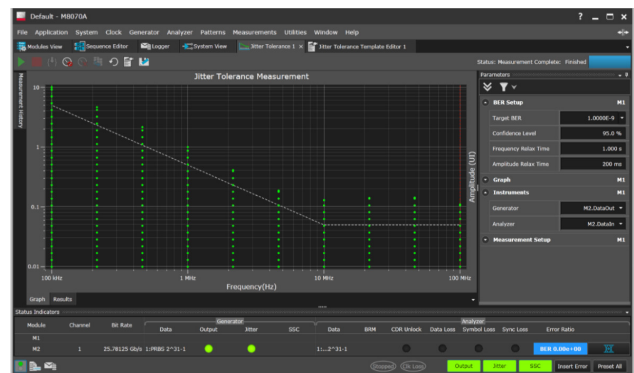

Jitter tolerance measurement result screen within M8070A system software.



Keysight's 81490A Reference Transmitter is designed to offer excellent eye quality as a reference for testing 10 GbE -LR/-ER, 10 G Fibre Channel and short reach transceivers, such as 10 GBase-SR, 40 GBase-SR4, 100 GBase-SR10 and according to 10 GFC Fibre Channel specifications.

The Reference Transmitter is available for Multimode 850 nm and Single-mode 1310 nm/1550 nm applications. Offering both 1310 nm and 1550 nm in one module gives the fastest reconfiguration between these two transmission bands without reconnecting. The integration in the LMS mainframe offers an integration of the reference transmitter into the N4917A stressed eye software package. Of course a separate usage of the transmitter is also supported with SCPI language.

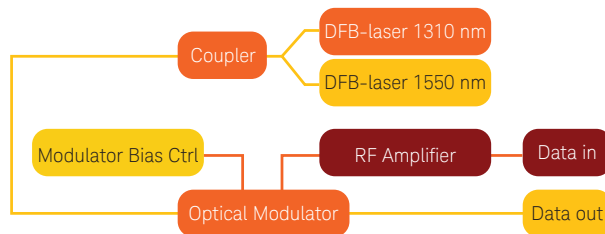

81490A-135 1310 nm/1550 nm reference transmitter

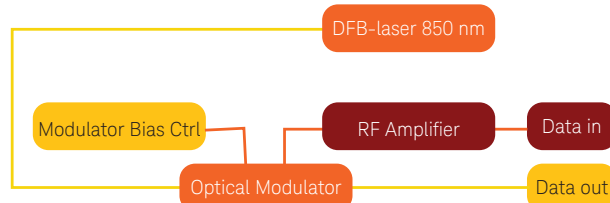

81490A-E03 850 nm reference transmitter

The separation of the signal source and the modulator is the only way to offer a zero-chirp modulation. This is essential for a clean and repeatable eye-diagram when modulating with an appropriate clean external source to fulfill the requirements of the IEEE standard. Another advantage of this design compared to directly modulated transmitters is the wide extinction ratio range that can only be achieved with this design.

Benefits

- Repeatable and reproducible measurements permit lower production test margins and improved specifications of the characterized devices
- Reliable measurements ensure comparability of the test results
- Support for full compliance to IEEE 802.3 stressed eye test in combination with the N4917A Optical Receiver Stress Test solution
- Wide extinction range offers highest test range coverage to ensure best quality of the tested devices under all target operating conditions
- Rapid test reconfiguration with dual-wavelength to switch between 1310 nm and 1550 nm by remote control or manually without exchanging a module
- Scalability with integration into industry-standard Keysight LMS platform extends your optical workbench capabilities

Application

- Reference transmitter for stressed eye compliance test according to IEEE 802.3 and 10 G Fiber Channel
- Creation of arbitrary optical modulation signals in combination with waveform generators
- General transmission system test with special pulse patterns in combination with a pattern generator

Specifications

- Operational data rate: 622 Mb/s to 12.5 Gb/s
- Electro-optical modulation bandwidth: 10 MHz to 33 GHz typ. Electro-optical conversion ratio: > 5 mW/V
- Maximum extinction ratio: > 10 dB
- Vertical eye closure penalty: VECP < 0.7 dB (Option E03), VECP < 0.5 dB (Option 135)
- Jitter (peak - peak): < 18 ps (Option E03), < 12 ps (Option 135)
- Relative intensity noise (RIN): RIN < -136 dB/Hz
- Transmitter wavelength: 850 ± 10 nm (Option E03), 1310 ± 10 nm, 1550 ± 10 nm (Option 135)
- Average optical output power: P > 0.0 dBm (Option E03), P > 5.0 dBm (Option 135)

NEW

www.keysight.com/find/n1077a

N1076A, N1077A Electrical and optical clock recovery solution for BER and waveform analysis

- Continuous, un-banded tuning from 50 MBd to 32 GBd
- Ultra low residual jitter: < 100 femtoseconds rms
- Golden PLL operation with a tunable loop bandwidth from 30 kHz to 20 MHz for configurable standard compliant test
- PLL BW/jitter transfer and phase noise/jitter spectrum analysis

Both bit-error-ratio-testers (BERTs) and DCA's require a clock signal to synchronize the measurement system to the incoming data stream. When the necessary synchronous clock/trigger is not available, a common solution is to derive a clock from the data being measured. The N1076A/N1077A standalone clock recovery instruments provide ideal performance for waveform analysis and BER test.

They can derive a clock from NRZ and PAM4 signals with rates as low as 50 MBd, as high as 32 GBd and any rate between, providing the ultimate in flexibility and value.

With jitter as low as 100 fs rms, the residual jitter of the output clock is virtually negligible, allowing accurate measurements of very low levels of signal jitter and high margin in jitter tolerance/receiver tests.

Electrical and optical clock recovery solutions up to 32 GBd:

N1076A Electrical Clock Recovery provides:

- 50 MBd to 32 GBd (continuous)
- Support for both NRZ and PAM4 signals
- Ultra-low residual random jitter < 100 fs RMS
- Jitter spectrum analysis (JSA) capability
- Golden phase-locked loop (PLL) for compliant operation

N1077A Optical/Electrical Clock Recovery provides:

- 50 MBd to 32 GBd (continuous) for both SM and MM applications
- Support for both NRZ and PAM4 signals
- Ultra-low residual random jitter < 100 fs RMS
- Jitter spectrum analysis (JSA) capability
- Golden phase-locked loop (PLL) for compliant operation
- Integrated O/E and clock recovery design
- Optical splitter: Integrated (Option SMS) or External - user supplied (Option SXT)

PLL and jitter spectrum analysis

Use 86100DU-400 software to make fast, accurate and repeatable measurements of phase-locked loop (PLL) bandwidth/ jitter transfer. With a precision jitter source, the 86108B, N1076A, or N1077A can be configured as a jitter receiver to create a PLL stimulus-response test system.

NEW

www.keysight.com/find/n1092d

Get 86100 DCA Accuracy with a Test Solution Designed for Manufacturing

The Keysight Technologies, Inc. 86100 digital communication analyzer (DCA) family is recognized as the industry standard for verifying optical transmitter compliance to communications standards. For years engineers have trusted the DCA to provide accurate and easy measurement of digital communication waveforms. The Keysight N109X DCA-M family has built on that legacy by using the high-performance elements of both the 86100 oscilloscope mainframe acquisition system and the optical and electrical channel hardware of the 861XX plug-in modules. The N1090A supports 1 to 10 Gb/s measurements, while the N1092 and N1094 are for use from 20 to 28 Gb/s. (Data rate ranges of the N1092 can be extended using Options PLK and IRC.)

Designed specifically for high-volume manufacturing test applications

Designed specifically for high-volume manufacturing test applications, the DCA-M provides the measurement accuracy of the 86100, without the extra cost associated with an R&D test solution. Be confident that your test results will never be questioned when performed with an N109X because end users of your transceivers and components are likely to use similar accurate, high-quality test systems to verify component performance.

Integrated Instruments built in a small form factor

Unlike the 86100, which uses modules to create a waveform analysis system, the N109X are completely integrated instruments built in a small form factor. Low-noise, high-sensitivity calibrated reference receivers – compliant to industry standard tolerances – are available for both multimode and single-mode signals at wavelengths from 750 to 1630 nm. N1090A noise is as low as 1 μ W, while N1092 noise is as low as 4 μ W, creating a measurement system with very high dynamic range. The sensitivity of the N1092 is significantly better than the comparable 86100 system making it an excellent solution for PAM-4 waveform analysis. Electrical channels are available with 20 GHz (N1090A), 30 GHz, and 50 GHz bandwidths (N1092/4).

Based on the modern FlexDCA User Interface

The N109X user interface and operating system is identical to the modern FlexDCA interface of the 86100D. A user-provided PC running N1010A FlexDCA software controls the N109X over a simple USB 2.0 or 3.0 connection.

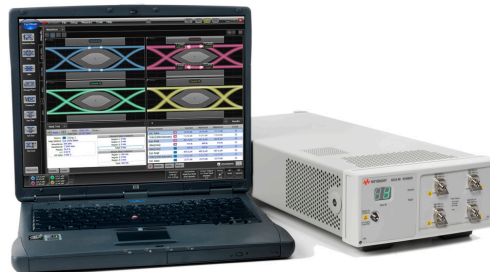



Controlling the N109X

- There are three ways to control the N109X system
- A PC directly connected to the N109X with a USB cable
 - An 86100D mainframe connected to the N109X with a USB cable. (The 86100D can then be controlled via GPIB or LAN)
 - For an automated test system environment, the simplest and preferred method to control the N109X is to connect the primary test system PC to a low-cost modern PC via LAN. The FlexDCA interface resides on the second PC. The second PC is then connected to the N109X via USB. This eliminates most issues of compatibility between an existing test system PC and the N109X hardware and can greatly simplify converting an 86100D system to an N109X system

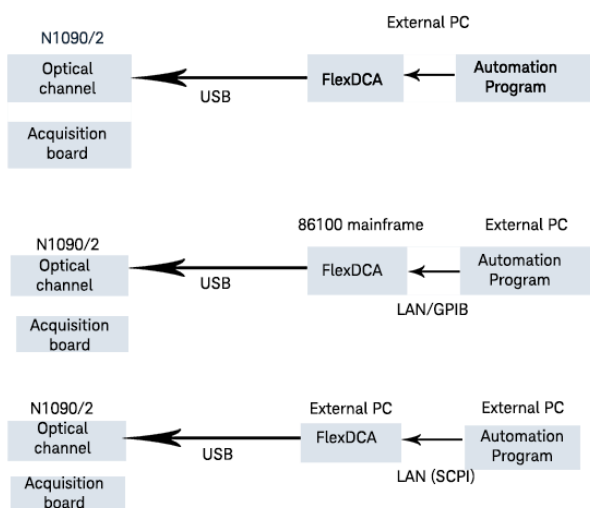

System setup

The following guidelines indicate the fundamental requirements for PC's connected to the N109X and running the FlexDCA interface:

For a single channel setup (N1090A or N1092A)

- Intel I3 processor or better
- 4 GB memory
- Windows 7 (32 or 64 bit)

For a parallel test setup (multiple instruments or multiple channels)

- Intel I5 or better
- 8 GB memory
- Windows 7 (64 bit)

SCPI over LAN

The communication API between your system controller and the PC is SCPI over LAN, either VXI-11 or HiSlip. If NI-VISA or IO Libraries are used to communicate with GPIB instruments, the switch to SCPI/LAN is very simple. It is important to note that there is no need to do any USB programming. This is all handled by the FlexDCA interface.

The FlexDCA interface is free

The FlexDCA interface is free and can be downloaded at www.keysight.com/find/flexdca_download. Remote programs previously developed using the 86100 FlexDCA interface can be leveraged directly to control an automated N109X system. Use FlexDCA SCPI programming tools to simplify conversion of legacy 86100-based automation to FlexDCA compatible code. Measurement results are generally 50 percent faster with the new N1090A, and up to 300 percent faster with the N1092/4 due to significantly faster sampling rates.

Reduce cost of ownership

Similar to the 86100, a reference clock, synchronous with the signal being measured, is required to trigger the N109X. The clock input range for the N1090A is 500 MHz to 12 GHz, and the N1092 and N1094 are 500 MHz to 28.5 GHz. Timebase calibration, previously performed at service centers, can now be performed by users, reducing cost of ownership and instrument down time.

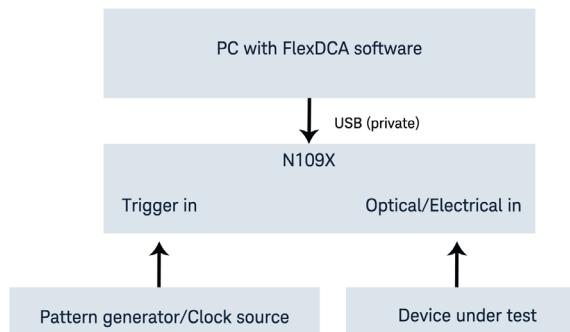

Fundamental measurements required to perform transmitter compliance tests such as eye-masks, extinction ratio, and other eye diagram parameters, are standard features of the N109X with N1010A system.

Cost Reduction

To reduce cost, the pattern lock feature of the 86100 is not available in the N1090A, but is optionally available with the N1092/4 Option PLK. Features that require pattern lock include Options 200 (advanced jitter analysis), 201 (advanced waveform analysis), 300 (advanced amplitude analysis/RIN), Option IRC (extends the operating range of the optical channels \pm 50% and creates reference receivers at arbitrary data rates between 10 and 42 Gb/s), and SIM (Infinisim waveform transformation software). Measurement features that require pattern lock will not operate when used with the N1090A system. Basic oscilloscope mode measurements of pulses rather than eye diagrams are limited to patterns less than 2 ns in duration with the N1090A.

NEW

www.keysight.com/find/n1092d

N1090A Configurations

Choose from the following reference receiver options to best meet your measurement needs. Select one option. Options cannot be combined. However if test needs change, the N1090A can be returned to a Keysight service center to convert from any of the five reference receiver options to one of the other four options listed. Unfiltered mode is not available in any option.



Option	Description
Option 140	1.244/1.25/1.229 Gb/s
Option 160	2.458/2.488/2.5 Gb/s
Option 180	3.072/3.125 Gb/s
Option 200	8.5/9.95/10.3/10.5/10.66/10.71/11.1/11.3 Gb/s
Option 204	8.5/9.95/10.3/10.5 Gb/s

A 20 GHz electrical channel is also available:

Option	Description
Option EEC	Add 20 GHz electrical channel

N1092/4 Configurations



All optical channels include optical reference receivers at 25.78, 26.56, 27.95, and 28.05 Gb/s. Using the FlexDCA user interface, simultaneous measurements of multiple channels can be performed in parallel without any degradation in speed or accuracy.

Model number	Description
N1092A	One optical channel
N1092B	Two optical channels
N1092C	One optical, two electrical channels
N1092D	Four optical channels
N1092E	Two optical, two electrical channels
N1094A	Two electrical channels
N1094B	Four electrical channels

N1092/4 Configurations

The N1092C and N1092E electrical channels have 50 GHz bandwidths that can be reduced by the user to 20, 33 and 40 GHz. Note that operation of Options 200, 201, 300, 401, 500, 9FP, and SIM can be achieved by having the appropriate licenses installed on the N1092, the computer controlling the N1092, or an 86100 mainframe used to control the N1092.

Option	Description
Option 168	25.78 Gb/s TDEC filter (100GBASE-SR4) (not available with the N1094)
Option 206	20.6 Gb/s ref receiver (not available with the N1094)
Option FS1	Increase sampling rate from 100 to 250 kSa/s
Option LOJ	Reduce residual jitter from 400 to < 200 fs
Option PLK	Add pattern lock capability
Option IRC	Extend optical channel bandwidth to 45 GHz and allow creation of reference receiver filters at any data rate from 8 to 42 Gb/s (not available with the N1094)
Option 200	Advanced jitter analysis. Provides extensive and accurate jitter decomposition, which is increasingly important as data rates increase and margins reduce. Quickly customize your view of many parameters and take advantage of advanced features such as jitter spectrum analysis
Option 201	Advanced waveform analysis. Its powerful features allow you to generate much deeper waveform files, integrate MATLAB analysis, and use the built-in linear feed-forward equalizer
Option 300	Advanced amplitude/noise analysis. Extends jitter mode capabilities into the amplitude domain and allows you to see the decomposition of the amplitude into several factors. Option 300 also reports relative intensity noise (RIN) and Q-factor
Option 401	Advanced eye analysis. For device testing with long patterns and obtaining BER-contour mask testing, Option 401 integrates with the classic or FlexDCA interfaces to decompose the jitter and amplitude interference measurements into the key parameters. When using the embedded capability within FlexDCA or the included automation application, you may characterize jitter on simultaneous multiple lanes and obtain concise and visual results
Option 500	Productivity package (Rapid eye, TDEC). Enables rapid eye acquisition, providing two significant benefits. First, unlike conventional sampling and data display, when an eye mask test is performed, every acquired sample will be compared to the mask, as the central eye is composed of all acquired samples. Effective throughput is improved at least 60 percent. Second, incomplete eye diagram displays that can occur when triggering at sub-rates are eliminated. Option 500 also includes the TDEC analysis required for 100GBASE-SR4 test
Option 9FP	PAM-N analysis. Eye width, eye height, eye skew, level amplitude, level noise, level skew, and linearity measurements
Option SIM	Infinisim Waveform Transformation software
Option 030	Configure electrical channels with a 30 GHz bandwidth (not available with the N1092)
Option 050	Configure electrical channels with a 50 GHz bandwidth (N1092C/E have standard 50 GHz bandwidths for the electrical channels)

The 86100 series digital communications analyzer is the industry standard for characterizing high-speed transmitter waveforms. Integrated, calibrated optical reference receivers coupled with built-in automated compliance software are the key to accurate measurements.

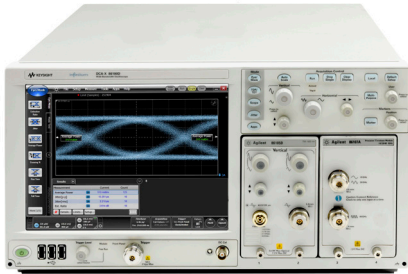

The 86100D DCA-X has been engineered for unmatched accuracy, insight, and ease-of-use. In addition to providing industry leading signal integrity measurements, the DCA-X provides:

Accurate characterization of optical waveforms

The 86100D is the ideal tool for viewing optical transceiver signals. A variety of plug-in modules are available with built-in optical receivers allowing the highest accuracy in waveform analysis. Industry standard reference receivers provide the correct frequency response to validate compliance to SONET/SDH, Ethernet, Fibre Channel and other specifications. Select from several plug-in modules to get the configuration that best matches your transceiver applications. Built-in test applications provide the following measurements:

- Automatic testing to industry standard eye masks
- Accurate measurement of eye-diagram parameters including extinction ratio, eye-height and width, crossing percentage
- Fast throughput and simultaneous multiple channel testing for extremely low cost-of-test
- Simultaneous parallel mask test for up to 16 channels with up to 64 parametric measurements

Powerful new INSIGHT

- Integrated de-embedding/embedding capability (using 86100D-SIM InfiniiSim-DCA license)
- Advanced signal processing such as filtering, FFT, differentiate and integrate functions
- New measurement capability, including Data Dependent Pulse Width Shrinkage (DDPWS), uncorrelated jitter (UJ), J2, J9 and more

Improved USABILITY

- Dual user interface:
 - FlexDCA – a new customizable vector-based user interface for scope, eye, and jitter measurements
 - DCA-J “classic” user interface
 - Customizable user-interface
- Display up to 64 measurements simultaneously
- ONE button setups

Improved PRODUCTIVITY

- Built-in waveform simulator with random/periodic jitter and noise generator
- Live or offline signal analysis (using N1010A FlexDCA remote access software)

NEXT GENERATION platform

- Supports up to 16 channels for testing high density ASIC/FPGA testing and parallel designs. New option 86100D-PTB integrates the precision timebase within the mainframe allowing ultra-low jitter for up to 16 channels
- Vertical gain and offset controls that can be assigned to all channels and functions
- User-defined multi-purpose button
- 3X faster CPU than DCA-J
- 100% backwards compatibility with all DCA modules

Improves margins and helps to differentiate products for a wide range of applications such as:

- Transceiver design and manufacturing
- ASIC / FPGA / IC design and characterization
- Signal integrity measurements on Serial bus designs
- Cables, Printed Circuit Boards (PCB)

Precision measurements on high-speed signals at the touch of one button!

- Scope mode yields the most accurate waveform measurements
- Eye/Mask mode provides fast and accurate compliance testing of transceivers
- TDR/TDT mode for precision impedance measurements with S-parameter capability. TDR edge speed faster than 10 ps with > 50 GHz BW
- Jitter and amplitude mode for comprehensive analysis of signal characteristics

Powerful analysis features provide greater insight

- Integrated de-embedding, embedding, and equalization capability
- Jitter spectrum and phase locked loop (PLL) analysis
- Jitter analysis on long patterns such as PRBS31

Lowest cost of test

- Modular platform supports up to 16 parallel channels
- Optimized algorithms designed for manufacturing test
- Modular – buy only what you need today knowing you can upgrade later
- Protect your investment – the 86100D is 100% compatible with all DCA modules

Scope mode

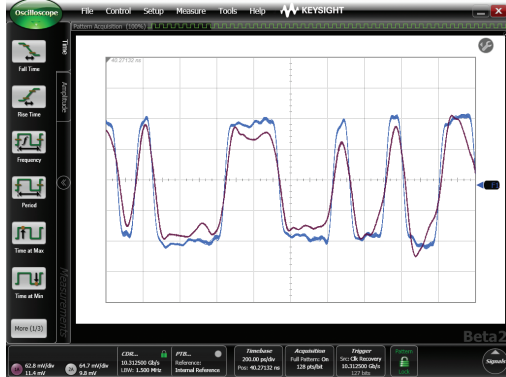

High-fidelity waveform characterization (Purple: raw trace, Blue: de-embedded waveform)

Eye/Mask mode

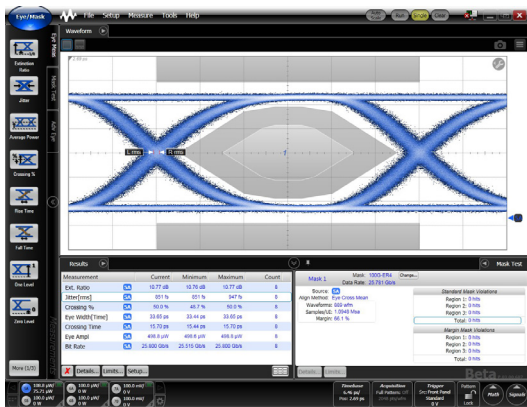

Fast transmitter characterization using eye-diagram analysis and automated mask margin measurements

Precision measurements, more margin, and more insight

The 86100D DCA-X oscilloscope combines high analog bandwidth, low jitter, and low noise performance to accurately characterize optical and electrical designs from 50 Mb/s to over 80 Gb/s. The mainframe provides the foundation for powerful insight and measurement capability, such as de-embedding of cables and fixtures, that improve margins and allow engineers to see the true performance of their designs.

Modular

The modular system means that the instrument can grow to meet your needs, when you need it. There's no need to purchase capability that you don't need now. The DCA-X supports a wide range of modules for testing optical and electrical designs. Select modules to get the specific bandwidth, filtering, and sensitivity you need. The DCA-X supports all modules in the DCA family and is 100% backwards compatible with the 86100C mainframe.

Jitter mode



Precision jitter, amplitude, and frequency analysis capability

TDR/TDT mode

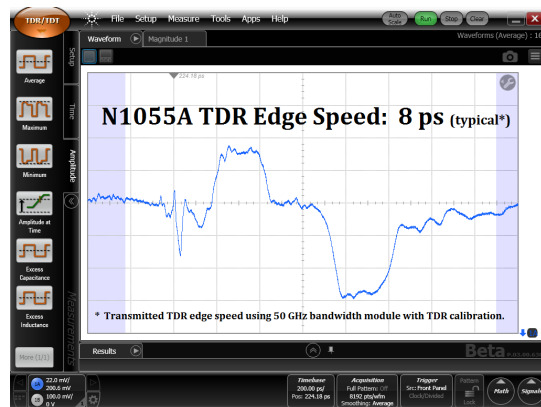

Accurate time domain reflectometry/transmission and S-parameter measurements

Software

The DCA-X provides powerful analysis capability that is enabled through licensed software options. Examples include 86100D-200 for fast and accurate jitter analysis, and 86100D-SIM for de-embedding and/or embedding of fixtures and cables.

The 86100D DCA-X features two user interfaces for optimum ease-of-use. It includes the classic DCA interface for complete backwards compatibility with earlier DCA mainframes. It also includes the new FlexDCA interface that provides new measurements and powerful analysis capability in a fully customizable application.

The following measurements are available from the tool bar, as well as the pull down menus. The available measurements depend on the DCA-X operating mode.

Oscilloscope mode

Time

Rise Time, Fall Time, Jitter RMS, Jitter p-p, Period, Frequency, + Pulse Width, - Pulse Width, Duty Cycle, Delta Time, [Tmax, Tmin, Tedge—remote commands only].

Amplitude

Overshoot, Average Power, V amptd, V p-p, V rms, V top, V base, V max, V min, V avg, OMA (Optical Modulation Amplitude).

Eye/Mask mode

NRZ eye measurements

Extinction ratio, Jitter RMS, Jitter p-p, Average Power, Crossing Percentage, Rise Time, Fall Time, One Level, Zero Level, Eye Height, Eye Width, Signal to Noise, Duty Cycle Distortion, Bit Rate, Eye Amplitude.

RZ eye measurements

Extinction Ratio, Jitter RMS, Jitter p-p, Average Power, Rise Time, Fall Time, One Level, Zero Level, Eye Height, Eye Amplitude, Opening Factor, Eye Width, Pulse Width, Signal to Noise, Duty Cycle, Bit Rate, Contrast Ratio.

Mask test

Open Mask, Start Mask Test, Exit Mask Test, Filter, Mask Test Margins, Mask Margin to a Hit Ratio, Mask Test Scaling, Create NRZ Mask.

Advanced measurement options

The 86100D's software options allow advanced analysis. Options 200, 201, and 300 require mainframe Option ETR. Option 202 does not require mainframe Option ETR. Option 401 does not require Options ETR and 200 unless a DDPWS measurement is required.

Option 200 enhanced jitter analysis software Measurements

Total Jitter (TJ), Random Jitter (RJ), Deterministic Jitter (DJ), Periodic Jitter (PJ), Data Dependent Jitter (DDJ), Duty Cycle Distortion (DCD), Intersymbol Interference (ISI), Sub-Rate Jitter (SRJ), Asynchronous periodic jitter frequencies, Subrate jitter components.

FlexDCA adds the following measurements:

Data Dependent Pulse Width Shrinkage (DDPWS), Uncorrelated Jitter (UJ), Jn (J2, J4, J5,...J9), Even-Odd Jitter (EOJ, or F/2).

Data displays

TJ histogram, RJ/PJ histogram, DDJ histogram, Composite histogram, DDJ versus Bit position, Bathtub curve (log or Q scale).

Option 201 advanced waveform analysis Measurements

Deep memory pattern waveform, user-defined measurements through MATLAB interface.

Data displays

Equalized waveforms using LFE, DFE, and CTLE equalizers.

Option 202 enhanced impedance and S-parameters

Option 300 amplitude analysis/RIN/Q-factor (requires Option 200)

Measurements

Total Interference (TI), Deterministic Interference (Dual-Dirac model, DI), Random Noise (RN), Periodic Interference (PI), and Inter-symbol Interference (ISI), RIN (dBm or dB/Hz), Q-factor.

Data displays

TI histogram, RN/PI histogram, ISI histogram

Option 400 PLL and jitter spectrum measurement software

Jitter spectrum/phase noise measurements

Integrated Jitter: Total Jitter (TJ), Random Jitter (RJ), Deterministic Jitter (DJ); DJ Amplitude/Frequency, Jitter Spectrum Graph, Jitter versus Time Graph, Frequency versus Time Graph, Jitter Histogram, Post Processed Jitter Measurements, Phase Noise Graph dBc/Hz versus frequency.

Phase Locked Loop (PLL) measurements

PLL bandwidth, PLL Peaking, Data Rate, Jitter Transfer Function (JTF) Graph, Observed Jitter Transfer (OJTF) Graph, JTF Model.

Option 401 advanced EYE analysis

Jitter measurements

Total Jitter (TJ), Random Jitter (RJ), Deterministic Jitter (DJ), J2 Jitter (J2), J9 Jitter (J9), Data Dependent Pulse Width Shrinkage (DDPWS)*

* Requires 86100D-200

Amplitude measurements

Total Interference (TI), Random Noise (RN), Deterministic Interference (DI), Eye Opening

Mask test (using Microsoft (TM) Excel workbook)

Pass/Fail status, hits or hit ratio limits

Option 500 productivity package

Improve the efficiency of eye-diagram testing by 40% or more

Option 9FP PAM4 Analysis

Eye/Mask Mode Measurements

Eye Width (EW), Eye Height (EH), Linearity, Level, TDECQ, Outer Optical Modulation Amplitude (OMA), Extinction Ratio (ER), Skew, and more.

Jitter/Amplitude Mode Measurements (requires Option 200/300)

Eye Width (EW), Eye Height (EH), Level, Skew, full jitter/amplitude decomposition, Symbol Error Rate (SER) floor, and more.

Option SIM infiniiSim-DCA

2-port de-embedding and embedding; 4-port de-embedding and embedding; add simulated random jitter and noise

TDR/TDT mode (requires TDR module)

Quick TDR, TDR/TDT setup

Normalize, Response, Rise Time, Fall Time, Δ Time, Minimum Impedance, Maximum Impedance, Average Impedance (Single-ended and Mixed-mode S-parameters with Option 202)

Additional capabilities

Standard functions

Standard functions are available through pull down menus and soft keys, and some functions are also accessible through the front panel knobs

Markers

Two vertical and two horizontal (user selectable)

TDR markers

- Horizontal – Seconds or meter
- Vertical – Volts, ohms or percent reflection
- Propagation – Dielectric constant or velocity

Limit tests

- Acquisition limits
- Limit test “Run Until” Conditions – Off, # of Waveforms, # of samples
- Report action on completion – Save waveform to memory, save screen image

Measurement limit test

- Specify number of failures to stop limit test
- When to fail selected measurement – inside limits

Outside limits, always fail, never fail

- Report action on failure – Save waveform to memory, save screen image, save summary
- Mask limit test
- Specify number of failed mask test samples
- Report action on failure – Save waveform to memory, save screen image, save summary

Configure measurements

Thresholds

- 10%, 50%, 90% or 20%, 50%, 80% or custom

Eye boundaries

- Define boundaries for eye measurements
- Define boundaries for alignment

Format units for

- Duty cycle distortion – Time or percentage
- Extinction/Contrast ratio – Ratio, decibel or percentage
- Eye height – Amplitude or decibel (dB)
- Eye width – Time or ratio
- Average power – Watts or decibels (dBm)

Top base definition

- Automatic or custom

Δ Time definition

- First edge number, edge direction, threshold
- Second edge number, edge direction, threshold

Jitter mode

- Units (time or unit interval, watts, volts, or unit amplitude)
- Signal type (data or clock)
- Measure based on edges (all, rising only, falling only)
- Graph layout (single, split, quad)

Quick measure configuration

When using the classic DCA interface, “Quick Measure” measurements are initiated by pressing the <Multi-Purpose> button on the front panel.

- Four user-selectable measurements for Each Mode, Eye-mask, TDR, etc.
- Default Settings (Eye/Mask mode) Extinction Ratio, Jitter RMS, Average Power, Crossing Percentage
- Default Settings (scope Mode) Rise Time, Fall Time, Period, Vamp_{td}

Histograms

Configure

- Histogram scale (1 to 8 divisions)
- Histogram axis (vertical or horizontal)
- Histogram window (adjustable window via marker knob)

Math measurements – Classic DCA user interface

- Four user-definable functions operator magnify, invert, subtract, versus, min, max
- Source – Channel, function, memory, constant, response

Signal processing measurements – FlexDCA

- Math – Add, Sub, Multiply, Average, Invert, Max, Min, Median
- Signal Processing – Difference (Differentiate), Summation (Integrate), Interpolation (Linear, Sin(x)/x), Filters: 4th Order Bessel, Butterworth, Gaussian
- Option – IRC allows extended operating range and improved frequency response of optical reference receivers
- Transforms – FFT, versus
- Equalizer (Opt 201) – Linear Feed-forward Equalizer (LFE, up to 64 taps)
- Simulation (Option SIM) – De-embedding, embedding, random jitter, random noise

Calibrate

All calibrations

- Module (amplitude), Horizontal (time base)
- Extinction ratio, probe, optical channel

Front panel calibration output level

- User selectable –2 V to 2 V

Touch screen configuration/calibration

- Calibration, Disable/enable touch screen

Additional capabilities

Waveform autoscaling

Autoscaling provides quick horizontal and vertical scaling of both pulse and eye-diagram (RZ and NRZ) waveforms.

Gated triggering

Trigger gating port allows easy external control of data acquisition for circulating loop or burst-data experiments. Use TTL compatible signals to control when the instrument does and does not acquire data.

Easier calibrations

Calibrating your instrument has been simplified by placing all the performance level indicators and calibration procedures in a single high-level location. This provides greater confidence in the measurements made and saves time in maintaining equipment.

Stimulus response testing using the Keysight N490X BERTs

Error performance analysis represents an essential part of digital transmission test. The Keysight 86100D and N490X BERT have similar user interfaces and together create a powerful test solution. If stimulus only is needed, the 81133A and 81134A pattern generators work seamlessly with the 86100D.

Transitioning from the Keysight 83480A and 86100A/B/C to the 86100D

While the 86100D has powerful new functionality that its predecessors don't have, it has been designed to maintain compatibility with the Keysight 86100A, 86100B, 86100C and Keysight 83480A digital communications analyzers and Keysight 54750A wide-bandwidth oscilloscope. All modules used in the Keysight 86100A/B/C, 83480A and 54750A can also be used in the 86100D. Since the 86100D includes the classic DCA interface, the remote programming command set for the 86100D designed for the 86100A/B/C will work directly. Some code modifications are required when transitioning from the 83480A and 54750A, but the command set is designed to minimize the level of effort required.

SCPI programming tools for FlexDCA

To facilitate easier and faster remote code development, the FlexDCA user interface includes several SCPI programming tools. The SCPI recorder, for example, records user interaction (via the scope front panel, mouse, or touchscreen) and reports the equivalent SCPI remote-programming command to the user via a Record/Playback pop-up window.

IVI-COM capability

Interchangeable Virtual Instruments (IVI) is a group of new instrument device software specifications created by the IVI Foundation to simplify interchangeability, increase application performance, and reduce the cost of test program development and maintenance through design code reuse. The 86100D IVI-COM drivers are available for download from the Keysight website.

VXII.2 and VXII.3 instrument control

The 86100D DCA-X provides LAN based instrument control.

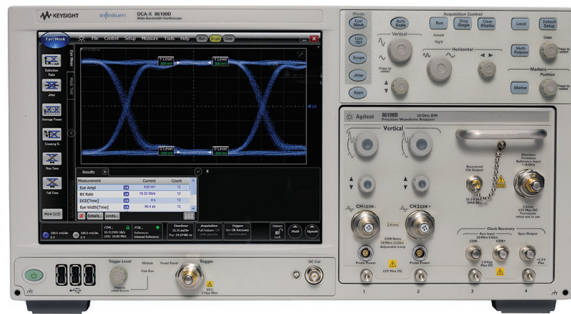

The ultimate in accuracy and ease-of-use for analyzing high-speed electrical NRZ/PAM4 signals

Highest accuracy scope featuring:

- Ultra-low jitter < 50 fs (typ.)
- Wide bandwidth
 - > 35 GHz (Option LBW)
 - > 50 GHz (Option HBW)
- Clock-data delay mitigation ("0 ns" delay)

Easy setup and operation:

- Simple one connection 'triggerless' operation
- Auto setup for serial bus differential signaling including PCI-EXPRESS®, SATA, HDMI, DisplayPort, SFP+, 8 GFC, 10 GbE

PLL characterization/Jitter transfer:

- Flexible operation: Data or clock input/output, 50 Mb/s to 2 Gb/s or 25 MHz to 16 GHz
- Compliant: PCI SIG approved, SONET/SDH

Integrated hardware clock recovery:

- Continuous clock recovery rates:
 - 50 Mb/s to 16 Gb/s (Option 216)
 - 50 Mb/s to 32 Gb/s (Option 232)
- Adjustable loop bandwidth (LBW)/Type-2 transition frequency (Peaking)
 - "Golden PLL" loop bandwidth adjustment 15 KHz to 20 MHz (rate dependent)
 - Peaking 0 to > 2dB (bandwidth dependent)
- Exceeds industry standards for SSC tracking

The Keysight 86108B precision waveform analyzer is a plug-in module used with the 86100C/D DCA Wide-Bandwidth Oscilloscope. An optimum combination ultra-low jitter, low noise, and wide bandwidth makes the 86108B the ideal choice in helping engineers develop and test designs for PCI-EXPRESS®, SATA, SAS, HDMI, DisplayPort, SFP+, Fibre Channel, CEI, Gb Ethernet, and any proprietary rate to 32 Gb/s. The 86108B overcomes conventional test equipment limitations and provides designers with the confidence that the waveform displayed by the oscilloscope is a faithful representation of the true device performance for today's technologies as well as future generations.

New architecture yields precision measurements and easy-to-use operation

The 86108B combines two high-bandwidth channels, an instrumentation-grade clock recovery which features variable loop bandwidth and peaking, and a precision timebase into a single unit.

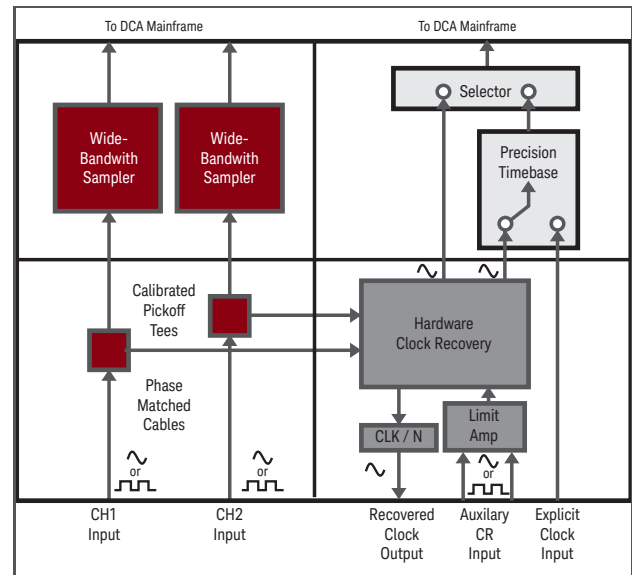

This combination results in the world's most accurate scope measurements available today. With setup similar to a real-time scope, it also provides significant ease-of-use advantages over traditional sampling scopes. The architecture virtually eliminates the trigger-sample delay inherent in most sampling instruments, and permits accurate and compliant measurement of large amounts of periodic jitter (e.g. SSC) without the use of specially matched cables which degrade performance.

PLL bandwidth, jitter transfer and jitter spectrum

The on-board phase detector of the 86108B allows for a precision measurement of phase-locked loop (PLL) bandwidth, sometimes referred to as jitter transfer. An external software application running on a PC controls the jitter source to provide a modulated stimulus to the device under test (DUT). The system is approved by the PCI SIG for PLL bandwidth compliance testing. The fast and flexible measurement can also test SONET/SDH and other PLL designs.



The Keysight B2900A Series of Precision Source/Measure Units are compact and cost-effective bench-top Source/Measure Units (SMUs) with the capability to output and measure both voltage and current. An SMU combines the capabilities of a current source, a voltage source, current meter and a voltage meter along with the capability to switch easily between these various functions into a single instrument.

Best-in-class performance

The Keysight B2900A series of SMUs provide best-in-class performance at a lower price than ever before. They have broad voltage (210 V) and current (3 A DC and 10.5 A pulsed) sourcing capability, excellent precision (minimum 10 fA/100 nV sourcing and measuring resolution) and high measurement throughput. In addition, the Keysight B2900A series possess a superior graphical user interface with various viewing modes that dramatically improve test productivity, debug and characterization. The versatile integrated source and measurement capabilities of the Keysight B2900 series SMUs make them an ideal choice for testing semiconductors, active/passive components and a variety of other devices and materials.

Four models

The Keysight B2900A series consists of four models, the B2901A, B2902A, B2911A and B2912A, differentiated through their available features (number of digits displayed, measurement resolution, minimum timing interval, supported viewing modes, etc.) and by the number of SMU channels (one or two) they contain. This makes it easy to select the exact price/performance point to meet your testing needs.

Broad application range

The B2900 series has a broad application range that spans from R&D and education uses to industrial development, test and manufacturing. Moreover, they work equally well as either standalone or system components.

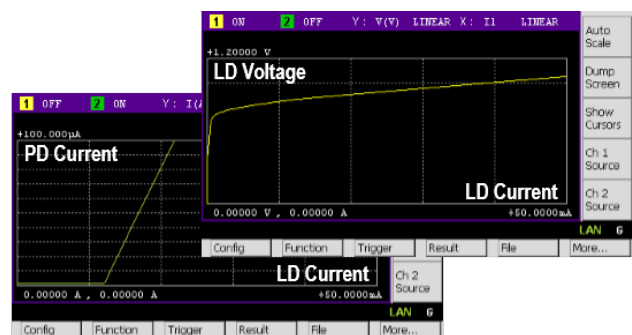

Key features & Specifications

Measurement capabilities

- Supports one-channel (B2901A and B2911A) and two-channel (B2902A and B2912A) configurations
- Minimum source resolution: 10 fA/100 nV, minimum measurement resolution: 10 fA/100 nV (B2911A and B2912A)
- Minimum source resolution: 1 pA /1 μ V, minimum measurement resolution: 100 fA/100 nV (B2901A and B2902A)
- Maximum output: 210 V, 3 A DC/10.5 A pulse
- Digitizing capabilities from 10 μ s (B2911A and B2912A) and 20 μ s (B2901A and B2902A) interval

General features

- Integrated 4-quadrant source and measurement capabilities
- The 4.3" color display supports both graphical and numerical view modes
- Free application software to facilitate PC-based instrument control
- High throughput and SCPI command supporting conventional SMU command set

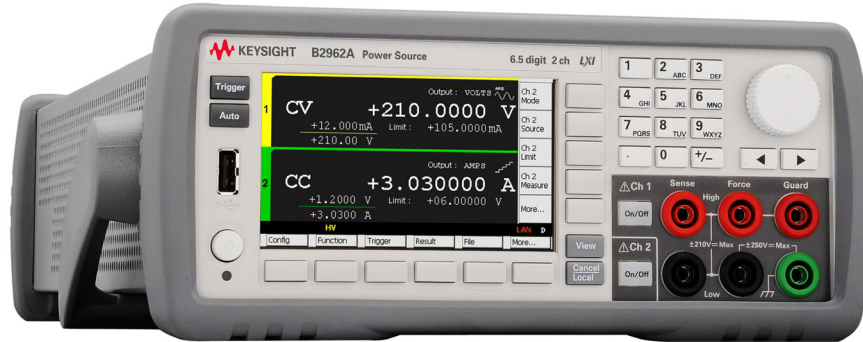

The B2961A/B2962A is a revolutionary power supply for precision low noise voltage/current sourcing that features 6.5 digit, 100 nV/10 fA resolution, 10 μ Vrms noise, bipolar 210 V/3 A (10.5 A pulse) range, innovative sourcing functions, and GUI (Graphical User Interface)

The world's only 6.5 digit source with a bipolar range of 100 nV to 210 V and 10 fA to 10.5 A

The Keysight B2961A/B2962A Power Source has broad voltage (up to ± 210 V) and current (up to ± 3 A DC and ± 10.5 A pulsed) sourcing ranges and excellent 6.5 digit resolution (minimum 100 nV/10 fA program resolution). Unlike a typical power supply/source, it supports 4-quadrant operation that gives you the freedom to accurately and precisely supply any voltage or current contained within its ranges regardless of polarity.

Noise floor of 10 μ Vrms (1 nVrms / $\sqrt{\text{Hz}}$ @ 10 kHz) outperforms even linear power supplies

Low noise performance is required for the development of noise sensitive devices such as VCOs (voltage controlled oscillators), ADC/DAC, new material based components, etc. However, conventional power supplies and sources have not been able to achieve the noise level required for these applications. The Keysight B2961A/B2962A supports an optional external low noise filter that enables ultra-low noise performance down to 10 μ Vrms and 1 nVrms/ $\sqrt{\text{Hz}}$ (at 10 kHz), providing unparalleled low noise performance in a low-cost bench-top power source.

Innovative sourcing capabilities enable test and evaluation not possible with conventional power supplies and sources

The Keysight B2961A/B2962A supports a number of innovative sourcing capabilities for test and evaluation that are not available on conventional power supplies and sources. For example, the Keysight B2961A/B2962A has the ability to generate not only DC signals but also pulsed, swept and arbitrary waveforms

(1 mHz to 10 kHz) in both voltage and current. Its arbitrary waveform generation capability supports common waveform types such as sine, ramp, square, etc. in addition to user-defined waveforms.

The Keysight B2961A/B2962A also supports an advanced programmable output resistance feature that allows you to specify either a particular output resistance or a specific voltage versus current source characteristic. This feature is ideal for emulating a wide variety of devices that are otherwise difficult to simulate.

General features

- Output voltage and current can be verified quickly using the built-in 4.5 digit voltage/current monitor
- Output voltage and current can be checked graphically on the 4.3" LCD front panel using the time-domain voltage/current waveform viewer
- Free PC application software for easy instrument control
- LXI Core conformant, USB2.0, GPIB, LAN and digital I/O interface

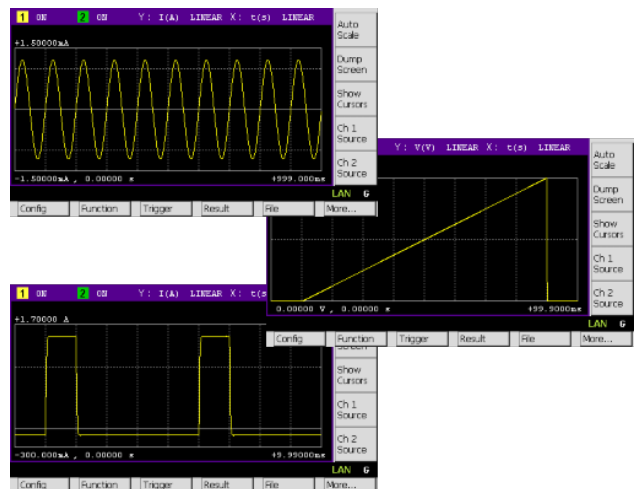

Determine the operating characteristics of a laser diode

The light-current-voltage (LIV) sweep test is a fundamental measurement to determine the operating characteristics of a laser diode (LD). In the LIV test, current applied to the laser diode is swept and the intensity of the resulting emitted light is measured using a photo detector (PD).

The Keysight Technologies, Inc. B2901/02/11/12A Precision Source/Measure Unit is a compact and cost-effective bench-top Source/Measure Unit (SMU) with the capability to output and measure both voltage and current. It covers currents from 10 fA to 3 A (DC)/10.5 A (pulse) and voltages from 100 nV to 210 V, which enables you to make a wide range of current versus voltage (IV) measurements more accurately and quickly than ever before.

Get support from multiple free software control options

In addition, the B2900A Series of SMUs comes with an intuitive graphical user interface (GUI) and multiple free software control options that make it easy for you to begin making productive measurements immediately, allowing you to choose the solution that best fits your particular application. These features make the B2900A Series of SMUs the best solution for LIV testing of laser diodes.

The B2902A and B2912A have two SMU channels, and each channel possesses accurate IV measurement capabilities as well as the ability to supply either constant or swept voltage/current. The B2902A and B2912A excellent choices for laser diode LIV testing.

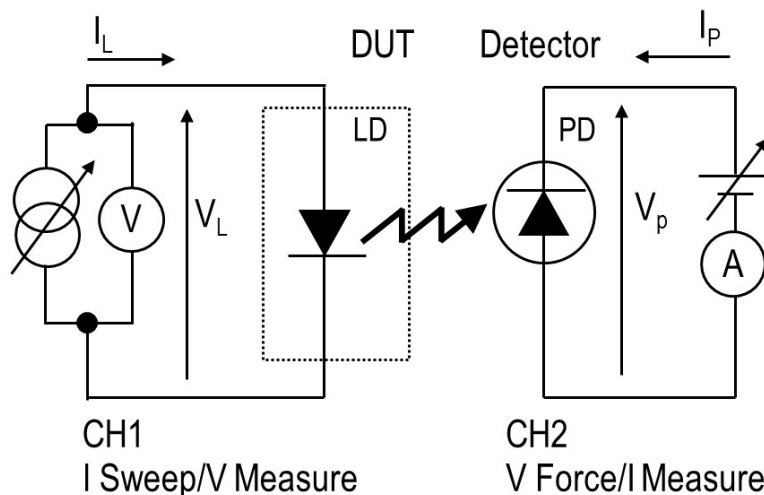
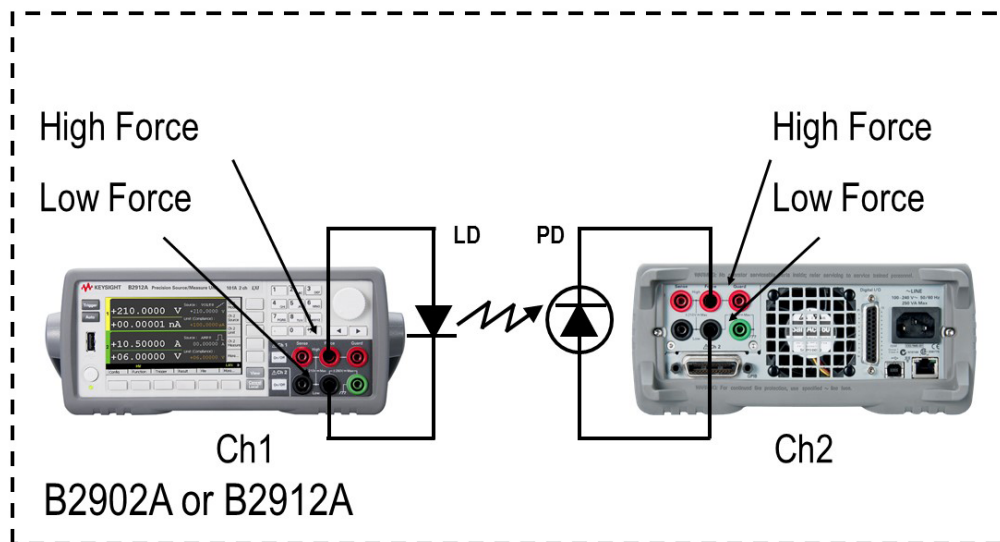

As shown in above using the B2902A or B2912A, you can easily measure the LIV characteristics of laser diodes, including tests such as a laser forward voltage, threshold voltage and slope efficiency.

In addition to its powerful and easy-to-use GUI, if you prefer PC-based instrument control, then the B2900A Series of SMUs comes with a range of free software control options to facilitate program development, allowing you to choose the solution that best fits your particular application.

BenchVue

The Keysight BenchVue software for the PC reinvents your bench testing by making it simple to connect and record results with your instruments without the need for programming. You can quickly and easily obtain results by viewing, logging and exporting measurement data and screen images with just a few mouse clicks. BenchVue provides a wide array of capabilities, depending on the chosen instrument application. These capabilities will vary according to the functionality of the instrument types and models, including the B2900A Series of SMUs, that are connected to the PC that is running the BenchVue software. See <http://www.keysight.com/find/benchvue> for more details.

Graphical Web Interface

The Keysight B2900A Graphical Web Interface provides functionality to allow access to the B2900A Series of SMUs over a LAN connection. The B2900A Series of SMUs is fully compliant with the LXI class C specification and contains a web server that provides a webpage with an interface to support the basic measurement functions of the B2900A. You can quickly and easily make measurements using a standard web browser by simply connecting the B2900A Series of SMUs to a PC using a LAN cable.



BenchVue

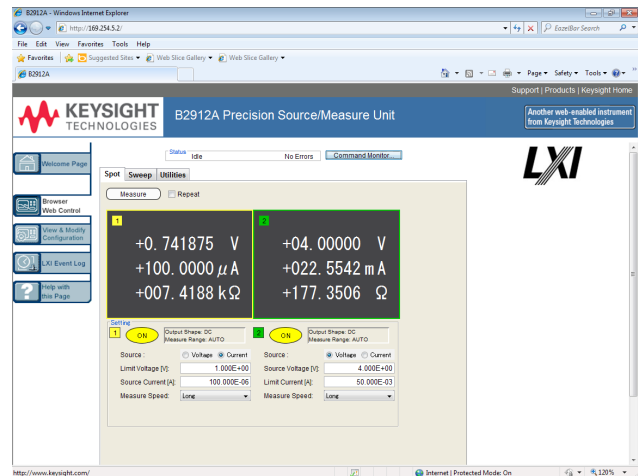

Graphical Web Interface

Quick I/V Measurement Software

The Keysight B2900A Quick I/V Measurement Software is a common software solution for the entire B2900 precision instrument family. It has powerful measurement capabilities to control the B2900A Series of SMUs over GPIB, USB or LAN connections (see Figure 6).

You can download this PC-based software for free from <http://www.keysight.com/find/quickiv>.

The Keysight B2900A Quick I/V Measurement Software also supports a variety of functions such as a sweep measurement, a sampling measurement, basic math functions, graphical display functions and the ability to save test results as CSV files.

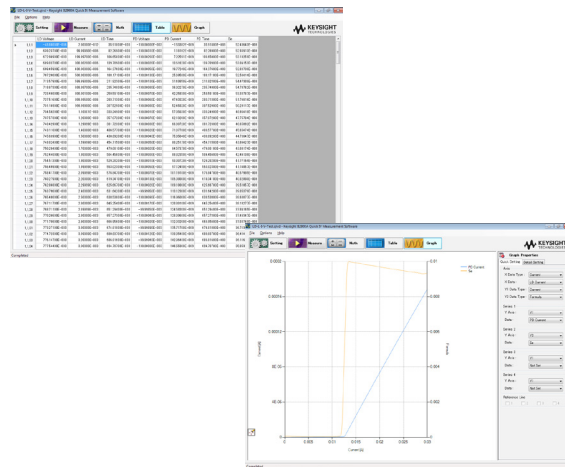
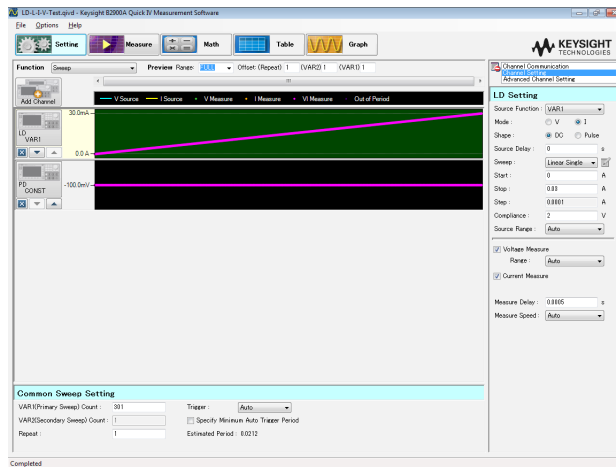

It is easy to make a quick measurement on a PC using the Keysight B2900A Quick I/V Measurement Software

EasyEXPERT Group+

The EasyEXPERT group+ software is the more powerful solution for detailed characterization and analysis of devices, circuits and materials. It supports efficient and repeatable characterization across the entire characterization process from measurement setup and execution to analysis and data management.

EasyEXPERT group+ makes it easy to perform complex characterization with ready-to-use furnished measurements (application tests), and gives you the option of automatically storing every test condition and piece of measurement data in a unique built-in database (workspace), ensuring that valuable information is not lost and that measurements can be repeated at a later date.

See www.keysight.com/find/easyexpert for more details.

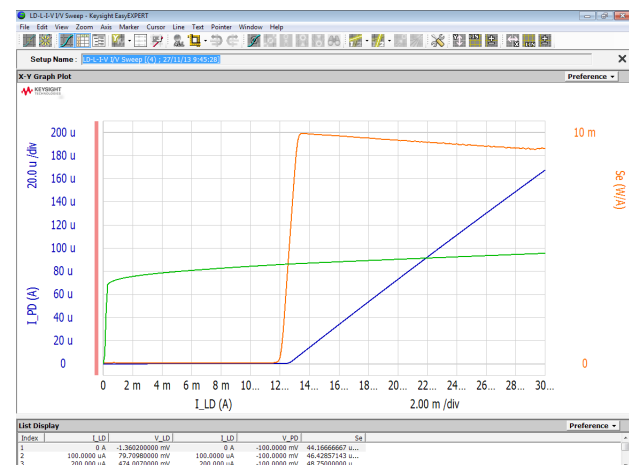
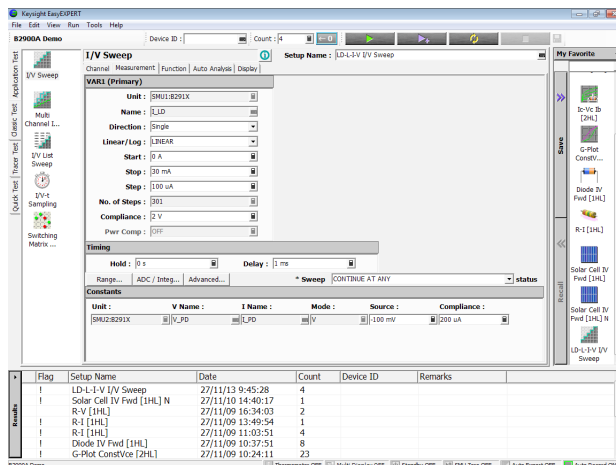

EasyEXPERT Group+ is a powerful solution for detailed characterization and analysis of devices, circuits and materials

Threaded head adapter

(Threaded adapter for 8152x Optical Heads, 8162x Optical Heads with 81624DD and 81628B Optical Heads)



81000FA FC/PC
 81000KA SC
 81000PA E-2000
 81000VA ST
 81003LA LC/F3000 FC/APC

Optical head adapter

These adapters are to be used with Keysight optical heads only. The connector adapters are needed to attach connectorized fibers.

Optical head adapters – with integral D-shape attachment for 8162xx optical head (except 81628B – see threaded version)



81001FA FC/PC
 81001KA SC
 81001PA E-2000
 81001LA LC/F3000
 81001MA MU

81003TD - MPO/MTP connector adapter

Optical head adapter with integral D-shape attachment for 8162xx optical head (except 81628B) for connection of ribbon cables with MT/MPO connectors. The adapter has connector guide pins and should be used with female cable connectors.



81001ZA - Blank adapter

Plug-in D-shape adapter for 8162x Optical Heads To be customized by customer.

Doesn't match to 8152x and High Power Optical Heads



81624DD - D-shape adapter

To connect threaded adapters to 8162x D-shape receptable. Included with new heads except 81628B. Remove for using head with D-shaped adapters.



Bare fiber adapters and interfaces

The Keysight Bare Fiber Connectivity Solutions enable the easy and repeatable adaptation of optical components to Keysight's standard optical heads (all 8152x and 8162x series) and sensor modules 81630B, 81634B.



- 81000BC Bare fiber connectivity set for 81623B, 81624B and 81626B (1x head adapter, 1 x 0-400 um holder, 1 x 400-900 um holder, 1 x gauge)
- 81000BI Bare fiber connectivity Set for 81630B and 81634B (1 x sensor adapter, 1 x 0-400 um holder, 1 x 400-900 um holder, 1 x gauge)
- 81000BT Bare FC set for 8152x and 8162x optical heads and threaded interface
- 81004BH Bare fiber holder Set (10 x 0-400 um holder)
- 81009BH Bare fiber holder Set (10 x 400-900 um holder)
- 81004BM / 9BM Bare fiber holder Set (4 x 0-400 um or 0-900 um holder, 1 x gauge)

N7740KI - SC

4-port SC connector for the multiport power meter series N7744A and N7745A.



N7740FI - FC

4-port FC connector for the multiport power meter series N7744A and N7745A.



N7740BI - Bare fiber adapter

Fiber holders not included; please add 81004BM or 81009BM



N7740ZI - Zeroing adapter

N7740LI - LC

4-port LC connector for the multiport power meter series N7744A and N7745A.



N7740MI - MU

4-port MU connector for the multiport power meter series N7744A and N7745A.

81000HI - E-2000 Connector interfaceFor **physical** contact connections

Recommended for angled and straight connector interfaces. Use with sources. Not for sensors.

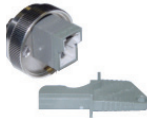
**81000PI - E-2000 Connector interface**For **non-physical** contact connections

Recommended for angled and straight connector interfaces. Use with sensors.

**81000LI - LC/F3000 Connector interface**For **physical** contact connections

Recommended for angled and straight connector interfaces. Use with sources.A

**81002LI - LC/F3000 Connector interface**For **non-physical** contact connections

Recommended for angled and straight connector interfaces. Use with sensors.

**81000FI - FC/PC Connector interface**

N-keying (key slot = 2.20 mm nominal)

For physical and non-physical contact connections

Recommended for angled and straight connector interfaces

**81000NI - FC/APC Connector interface**

R-keying (key slot = 2.00 mm nominal)

For physical and non-physical contact connections

Recommended for angled and straight connector interfaces

**81000MI - MU Connector interface**For **physical** contact connections

Recommended for angled and straight connector interfaces. Use with sources.

**81002MI - MU Connector interface**For **non-physical** contact connections

Recommended for angled and straight connector interfaces. Use with sensors.

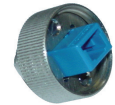
**81000KI - SC Connector interface**

For physical and non-physical contact connections

Recommended for angled and straight connector interfaces

**81000VI - ST Connector interface**

For physical and non-physical contact connections

Recommended for angled and straight connector interfaces

**81000SI - DIN 4108/47256 Connector interface**

For physical and non-physical contact connections

Recommended for angled and straight connector interfaces

**81000UM - Universal feedthrough adapter**

To adapt 81000BR or HMS-10 connectors to any other appropriate connector. In combination with a Keysight 81000xl connector interface, this adapter allows you to mate an HMS-10 connector to another HMS-10, FC/PC/SPC, APC, DIN, ST, E-2000, or SC connector. It can also be used to mate a Keysight 81000BR reference reflector to a connector under test. The Keysight 81000UM is a through adapter only. It can not be used at the fiber interfaces of the modules.

**81000BR - HMS-10 Reference reflector**

- Return loss = 0.18 dB \pm 0.1 dB (96% \pm 2%) typ.
- Wavelength range: 1200 to 1600 nm



A gold-plated HMS-10 connector for use in measuring return loss of optical connectors. It allows you to establish a precise reference for reflection measurements. Return loss is 0.18 dB \pm 0.1 dB (96% \pm 2%)

NEW

www.keysight.com/find/oct

Keysight's universal optical interface is on the market for more than 25 years and allows users to adapt optical test instrumentation to a multitude of optical connector standards.

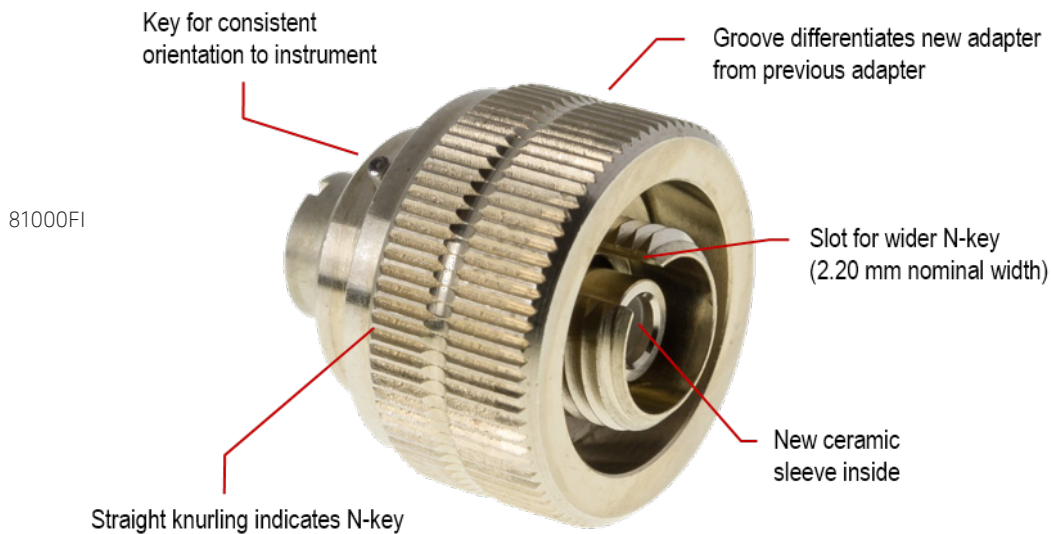

The new ceramic sleeve has been reinforced to combine robustness with greater precision and less wear. The most popular connector interfaces, used for FC/PC and FC/APC connectors, are now equipped with the new technology.

- A new ceramic sleeve centers the instrument's ferrule to the attached connector's ferrule, ensuring nearly wear-free and abrasion-free alignment.
- A groove on the knurled outer ring of the screw-on interface differentiates the new adapter from the current adapters that are equipped with a metal sleeve.
- Metallic sleeves have been considered the most abuse-forgiving alignment solution. However, metal surfaces inside the tube wear and leave contamination at the most critical place, the optical connector plane. Over time, metal sleeves open up enough to degrade the connection alignment.

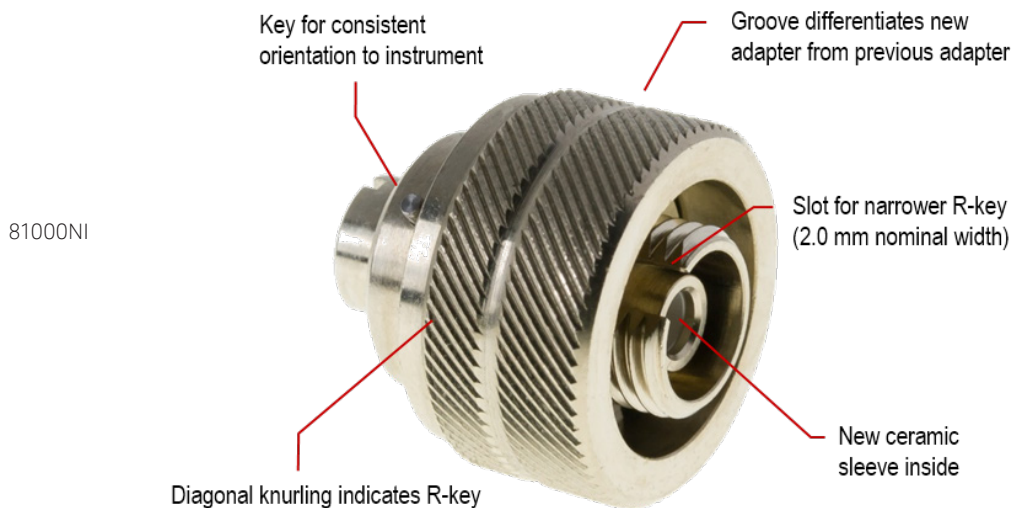

Power meter heads	81623B	81623B C01/C85	81620B	81624B	81624B C01	81626B	81626B C01	81628B
Sensor element	Ge, ø 5 mm	Ge, ø 5 mm	Si, ø 5mm	InGaAs, ø 5mm	InGaAs, ø 5mm	InGaAs, ø 5mm	InGaAs, ø 5mm	Sphere
Wavelength range [nm]	750 to 1800	750 to 1800	450 to 1020	800 to 1700	800 to 1700	850 to 1650	850 to 1650	800 to 1700
Power range [dBm]	-80 to +10	-80 to +10	-90 to +10	-90 to +10	-90 to +10	-70 to +27	-70 to +27	-60 to +40
Uncertainty at ref. cond.	±2.2%	±1.7% / ±2.2%	±2.2%	±2.2%	±1.5 %	±3.0 %	±2.5 %	±3.0 %
Rel. uncertainty due to polarization (typ.)	< ±0.005 dB	< ±0.005 dB		±0.002 dB	±0.002 dB	±0.002 dB	±0.002 dB	≤ ±0.006 dB
Rel. uncertainty spectral ripple (typ.)	< ±0.003 dB	< ±0.003 dB		≤ ±0.002 dB	≤ ±0.002 dB	≤ ±0.002 dB	≤ ±0.002 dB	≤ ±0.02 dB
Return loss (typ.)	> 55 dB	> 55 dB		60 dB	60 dB	> 45 dB	> 47 dB	> 75 dB
Averaging time (minimal)	100 µs	100 µs	100 µs	100 µs	100 µs	100 µs	100 µs	100 µs
Analog output	Yes	Yes	Yes	Yes	Yes	Yes	Yes	Yes

Power modules	81630B	81634B	81635A	81636B	N7744A	N7745A	N7747A	N7748A
Sensor element	InGaAs	InGaAs	InGaAs	InGaAs	InGaAs	InGaAs	InGaAs	InGaAs
No. of channels	1	1	2	1	4	8	2	4
Core diameter	Up to 100 µm	Up to 100 µm	Up to 62.5 µm	Up to 62.5 µm	≤ 62.5 µm	≤ 62.5 µm	Up to 100 µm	Up to 100 µm
Wavelength range [nm]	970 to 1650	800 to 1700	800 to 1650	1250 to 1640	1250 to 1650	1250 to 1650	1250 to 1650	1250 to 1650
Power range [dBm]	-70 to +28	-110 to +10	-80 to +10	-80 to +10	-80 to +10	-80 to +10	-110 to +10	- 10 to +10
Uncertainty at ref. cond.	± 3.0%	± 2.5%	± 3.5%	± 3.0%	± 2.5%	± 2.5%	± 2.5%	± 2.5%
Rel. uncertainty due to polarization (dB)	< ± 0.01	< ± 0.005	Typ. < ± 0.015	Typ. ± 0.015	Typ. < ± 0.01 dB	Typ. < ± 0.01 dB	< ± 0.005	< ± 0.005
Rel. uncertainty spectral ripple (dB)	< ± 0.005	< ± 0.005	Typ. < ± 0.015	Typ. ± 0.015	Typ. < ± 0.01 dB	Typ. < ± 0.01 dB	< ± 0.005	< ± 0.005
Memory/channel (samples)	20 k	20 k	20 k	100 k	2 x 1 M	2 x 1 M	2 x 1 M	2 x 1 M
Averaging time (minimal)	100 µs	100 µs	100 µs	25 µs	1 µs	1 µs	100 µs	100 µs
Analog output	Yes	Yes	No	Yes	No	No	Yes	Yes

1240 nm	1360 nm	1460 nm	S-Band	C-Band	L-Band	U-Band
O-Band	E-Band					
Compact, JET, iTLA-based						
				81950A-310 N771xA-340	81950A-301 N771xA-304	
Compact, ECL-based						
			81989A		81949A	
Swept-wavelength measurements						
					81940A	
				81960A-E62		
			81980A			
Full-size, ECL-based						
					81606A-216, 81608A-216 (200 nm)	
					81606A/7A/8A -116 (150 nm)	
			81602A-013			
				81600B-140, 81600B-142		
			81606A-113, 81608A-113			

Device under test	Bit rate	Application examples	Typical requirements	Recommended Keysight BERT/AWG	
				For R&D Characterization, Compliance	For Manufacturing
High-speed serial receiver in computer buses and backplanes	< 16 G	QPI, PCI Express, SATA, SAS, USB3, TBT, DP, SD, UHS II, MIPI D-PHY/ M-PHY, HDMI	data rates < 16 Gb/s, calibrated jitter, SSC, ISI and S.I., clock recovery, pattern sequencing	J-BERT M8020A M8030A	n/a
	< 10 G	MIPI D-PHY/ C-PHY HDMI, MHL	data rates < 10 G, no loopback, 3-wire or multi-level	M8190A, M8195A	n/a
Backplanes, Cables, SERDES, AOC, Repeaters	> 10 G to 28 G	10Gbase-KR4/-CR4, CEI, IB, TBT CAUI, CAUI 2/4 10Gbase-KR	data rates > 10 Gb/s, de-emphasis, x-talk, PRBS	J-BERT M8020A, M8062A, N4960A, N4965A, (J-BERT N4903B/N4877A)	n/a
	< 58 G	CEI-56G/112G, 400 GbE	PAM-4, NRZ, PRBS	M8040A	n/a
Optical transceivers and subcomponents: 0.6 to 58Gb/s	< 58 G	400 GbE, 64G FC	PAM-4, NRZ, PRBS	M8040A	
	< 28 G	40 G/100 GbE, 32 G FC, CFP2/4	Data rates > 16 Gb/s clean signals, PRBS	N4960A, N4967A J-BERT M8020 + M8062A	N4960A, N4967A
	10 G	10 G/40 GbE, PON, OTN, 8 G/16 G FC, QSFP, SFP+, QFP	Data rates 3 to 15 Gb/s, PRBS optical stress and sensitivity, framed bursts	J-BERT M8020A, (N4903B+N4917A), M8030A	

Evolving Since 1939

Our unique combination of hardware, software, services, and people can help you reach your next breakthrough. We are unlocking the future of technology.

From Hewlett-Packard to Agilent to Keysight.

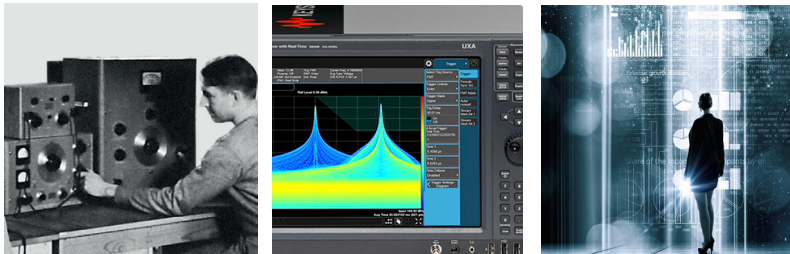

myKeysight

myKeysight

www.keysight.com/find/mykeysight

A personalized view into the information most relevant to you.

www.keysight.com/find/emt_product_registration

Register your products to get up-to-date product information and find warranty information.

KEYSIGHT SERVICES

Accelerate Technology Adoption.
Lower costs.

Keysight Services

www.keysight.com/find/service

Keysight Services can help from acquisition to renewal across your instrument's lifecycle. Our comprehensive service offerings—one-stop calibration, repair, asset management, technology refresh, consulting, training and more—helps you improve product quality and lower costs.



Keysight Assurance Plans

www.keysight.com/find/AssurancePlans

Up to ten years of protection and no budgetary surprises to ensure your instruments are operating to specification, so you can rely on accurate measurements.

Keysight Channel Partners

www.keysight.com/find/channelpartners

Get the best of both worlds: Keysight's measurement expertise and product breadth, combined with channel partner convenience.

www.keysight.com/find/lightwave

For more information on Keysight Technologies' products, applications or services, please contact your local Keysight office. The complete list is available at:

www.keysight.com/find/contactus

Americas

Canada	(877) 894 4414
Brazil	55 11 3351 7010
Mexico	001 800 254 2440
United States	(800) 829 4444

Asia Pacific

Australia	1 800 629 485
China	800 810 0189
Hong Kong	800 938 693
India	1 800 11 2626
Japan	0120 (421) 345
Korea	080 769 0800
Malaysia	1 800 888 848
Singapore	1 800 375 8100
Taiwan	0800 047 866
Other AP Countries	(65) 6375 8100

Europe & Middle East

Austria	0800 001122
Belgium	0800 58580
Finland	0800 523252
France	0805 980333
Germany	0800 6270999
Ireland	1800 832700
Israel	1 809 343051
Italy	800 599100
Luxembourg	+32 800 58580
Netherlands	0800 0233200
Russia	8800 5009286
Spain	800 000154
Sweden	0200 882255
Switzerland	0800 805353
	Opt. 1 (DE)
	Opt. 2 (FR)
	Opt. 3 (IT)
United Kingdom	0800 0260637

For other unlisted countries:

www.keysight.com/find/contactus
(BP-9-7-17)

DEKRA Certified
ISO 9001 Quality Management System

www.keysight.com/go/quality

Keysight Technologies, Inc.
DEKRA Certified ISO 9001:2015
Quality Management System



This information is subject to change without notice.
© Keysight Technologies, 2016 - 2017
Published in USA, December 1, 2017
5989-6753EN
www.keysight.com